

Investigation of Dense Cesium Laser Plasma

J. YAMADA, O. LANDEN, R. WINFIELD and D.D. BURGESS

高密度セシウムレーザプラズマの研究

山田 諄, O. Landen, R. Winfield and D.D. Burgess

A dense Cs vapour is irradiated by a tunable dye laser with the maximum power of 500 KW and the half width of 20 ns, and ionization mechanisms of the laser induced Cs plasma are investigated. An initial electron is produced by laser absorptions of the Cs molecular. At the high Cs number density, enough number of the Cs(6P) atoms are excited by electron collisions. If the dye laser is tuned to the atomic transition of 6P—9S, the Cs(6P) excited atom absorbs the further laser photon and is ionized. At the low Cs density, two-photon ionization is a main ionization process.

§ 1. Introduction

Recently, a strongly coupled non-Debye plasma, relevant to the conditions in inertial confinement fusion schemes or stellar interiors has been a subject of great interest. It is important to find such a source of strongly coupled plasma suitable for precise quantitative spectroscopic study. A dense, cold non-Debye metal vapour plasma can be efficiently obtained by the irradiation of the resonance tunable dye laser with the relatively lower power. Before the derivations of the non ideal plasma from Random Phase Approximation behaviour are confirmed, the study on the ionization mechanism of such a plasma is important, or the mechanism itself is also of interest in its own right. A number of theoretical explanations of the ionization mechanism have been proposed which at present remain in competition and at variance with each other. These processes can be separated into three categories: Super-Elastic Electron Production¹⁾, Multi-Photon Ionization²⁾ and Associative Ionization.³⁾

In order to make it clear, we have carried out some experiments on the ionization mechanism, in which a Cs vapour with the atomic density of $10^{16} \sim 10^{17} \text{ cm}^{-3}$ was irradiated by a tunable dye laser with the output energy of 10 mJ and the half width of 20 ns.

§ 2. Experiments

The experimental arrangement is shown in Fig. 1. A Nd glass laser system manufactured by J. K Laser (System 2000) was used to pump a tunable dye laser. Second harmonic of the glass laser is obtained by frequency doubling in non-linear KDP crystal. The dye laser consists of an oscillator and two amplifiers. The oscillator has a cavity with two 100% reflecting

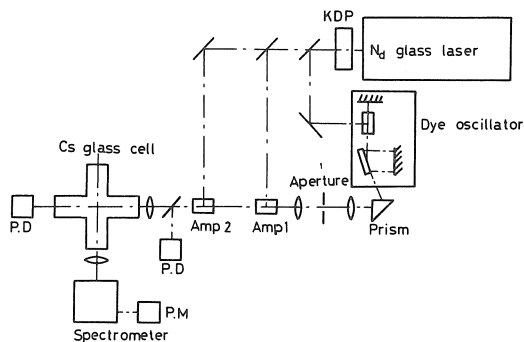

Fig.1 Experimental arrangement

mirrors and a grating with 1800 lines/mm. The laser radiation is further spectrally filtered by passage through a prism followed by focussing onto a pinhole aperture. A maximum power of 500 KW in a pulse with the half width of 20 ns over 2 mm^2 is achieved.

The output light of the dye laser is focussed on a Cs glass cell by a lens with focal length of 20 cm. The Cs glass cell made of a pyrex glass is a heat-pipe one with four windows. The diameter of the glass cell is 16 mm ϕ and the length is 150mm. A fine copper mesh is inserted in it. The central part of the cell is heated by a ribbon heater and the end parts are cooled by the circulation of water.

The fluorescence at the right angle is focussed on a slit of a Bentham spectrometer. The spectrally dispersed light is collected by a photomultiplier (RCA 7265). The transmitted laser light is observed by a PIN photodiode with the risetime of 1 ns.

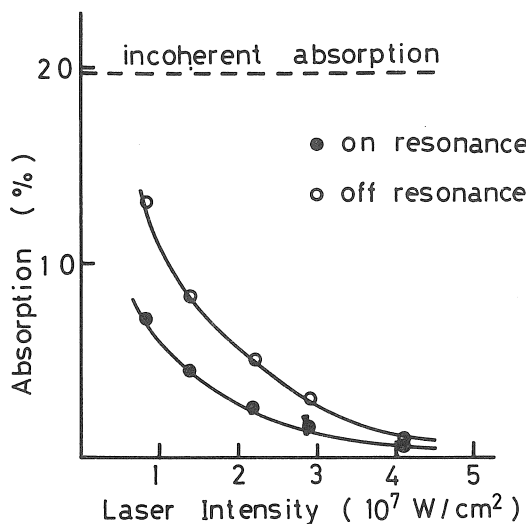

Fig. 2 Absorption versus laser intensity;
 $N_{Cs} = 2 \times 10^{17} \text{ cm}^{-3}$

§ 3. Experimental Results and Discussions

At first, we observed the transmitted laser light to get some information of the early stage of the ionization during the laser pulse. The results were in strong contrast to those reported by Tam and Happer⁴⁾ in which cw dye laser was used. They reported a sudden attenuation jump in the transmitted laser light as the Cs atomic density was increased around 10^{17} cm^{-3} , and that the transmitted laser light decreased with increasing the laser power. We in contrast observed no sudden change in the percentage of the transmitted laser light as the Cs atomic density was increased. The absorption through the Cs vapour was always very weak and was lower than the experimental error due mainly to shot-to-shot variation. The wavelength of our dye laser was around 6354 Å corresponding to the Cs atomic transition $6P_{1/2} - 9S_{1/2}$. We fine-tuned the laser around the line center over a range of about 0.1 Å, but obtained the same result.

The absorption of an incoherent light using a white light bulb was then observed and was 20% at the Cs density of $2 \times 10^{17} \text{ cm}^{-3}$. The conclusion therefore is that the intensity of our laser was sufficient that the absorption must be saturated. The intensity dependence of the absorption was then observed in more detail. To reduce the experimental error due to the shot-to-shot variation, the incident laser intensity was simultaneously monitored and the transmitted light was normalized to the incident intensity. The experimental results averaged over 4 or 6 shots are shown in Fig. 2, where "on resonance" means the dye laser is tuned to the line center within $\pm 0.1 \text{ Å}$ and "off resonance" $+3.5 \text{ Å}$ apart from the line center. The

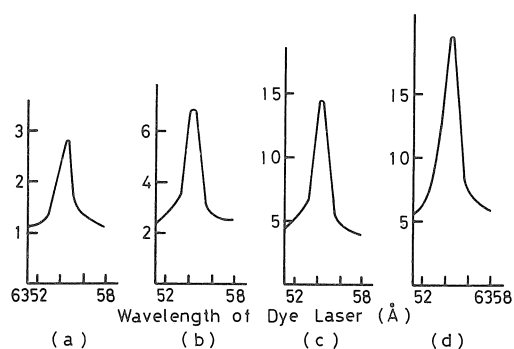

Fig. 3 Tuning effect in fluorescence $6P_{3/2} - 7D_{5/2}$;
 (a) $N_{Cs} = 10^{16}$, (b) $N_{Cs} = 2 \times 10^{16}$,
 (c) $N_{Cs} = 5 \times 10^{16}$ and (d) $N_{Cs} = 10^{17} \text{ cm}^{-3}$

absorption increases with decrease of laser intensity, which is opposite to the result observed using cw laser. At the lower intensity limit, our results tend towards that observed using the incoherent light.

At first, the laser light might be absorbed by the Cs molecular dimer, but the laser light is so intense that almost all the Cs molecules should be excited. With the assumption that the laser pulse is a triangular one with a half-width of 20 ns, that the Cs molecular density is $3.2 \times 10^{15} \text{ cm}^{-3}$ and that the molecular absorption is 20% which is reasonable because the absorption cross section of the Cs_2 is 0.63 Å^2 at 6354 Å ⁵⁾, all the molecules should be excited within 2 ns at the laser intensity of $4 \times 10^7 \text{ W/cm}^2$. The energy necessary to excite all the molecules is only 0.2% of the input laser energy. The Cs_2 ground state is excited to a repulsive Cs_2^* state, which dissociates and produces Cs (6p) atom either directly or via atomic cascades. The Cs (6p) excited atoms should then absorb further laser light on resonance. The absorption on resonance is observed to be about 2 times larger than that off resonance.

Next, we looked for any pronounced resonance effect, by tuning very closely to the line center of $6P_{1/2} - 9S_{1/2}$. Tam and Happer reported having to fine tune within $\pm 0.2 \text{ cm}^{-1}$ to produce a plasma using a cw laser. We did not find any large resonance effect in the electron density under the same conditions as shown later, but we did find a strong resonance effect in the fluorescence signal. For on resonance, the large spike in the fluorescence signal is found at the high pressure. Stray scattered laser light was eliminated as a possible explanation. After making efforts to eliminate any stray light, such a spike was not obtained at the line wing or at a wavelength between lines but remained at the line center. The time at which the fluorescence signal reaches a maximum, coincides with the peak of the laser pulse at the high

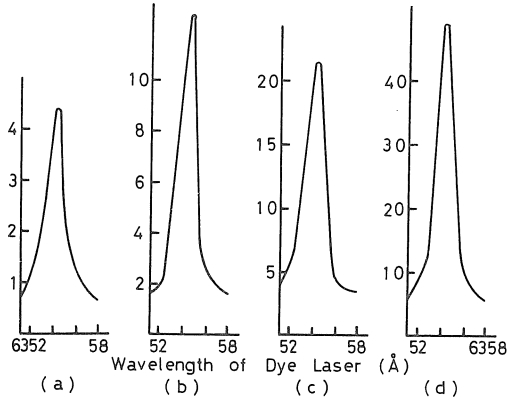

Fig.4 Tuning effect in fluorescence $6P_{3/2}-9S_{1/2}$,
 (a) $N_{Cs}=10^{16}$, (b) $N_{Cs}=5 \times 10^{16}$,
 (c) $N_{Cs}=10^{17}$ and (d) $N_{Cs}=2 \times 10^{17} \text{cm}^{-3}$

pressure, while it is about 10 ns later at the low pressure.

The peak values of the fluorescence $6P_{3/2} - 7D_{5/2}$ are plotted against the wavelength of the dye laser in Fig. 3. No significant difference in the half-width of the tuning curve was found, when the Cs density was increased. The ratio of the fluorescence peak on resonance to off resonance slightly increases as the Cs density increases, reaching about a factor of 3 at the Cs density of 10^{17}cm^{-3} . The ratio in other lines is of roughly the same magnitude except that for $6P_{3/2} - 9S_{1/2}$ (6586 Å), which represents the $9S_{1/2}$ excited population. The tuning curve for $6P_{3/2} - 9S_{1/2}$ is shown in Fig. 4. The ratio is largest and is about 8 at the Cs number density of 10^{17}cm^{-3} . This establishes that the laser is really tuned to the line center of $6P_{1/2} - 9S_{1/2}$, and that the fluorescence is indeed due simply to the 6P excited atoms absorbing the laser light and being excited to the 9S state.

If it is assumed that all the Cs molecules are excited, dissociate and produce the Cs (6P) atoms, the attenuation length for 6354 Å (oscillator strength is 7×10^{-3})⁶⁾ is less than 0.6 mm at the Cs_2 density of $3.2 \times 10^{15} \text{cm}^{-3}$. These Cs (6P) atoms absorb the laser light and are excited to 9S state within 1 ns at the laser intensity of $4 \times 10^7 \text{W/cm}^2$.

The decay time constant of the fluorescence spike is of the same order as the length of the laser pulse at the high pressure, while it becomes longer with decreasing the Cs number density. The decay time constant versus the Cs number density is shown in Fig. 5, where the observed decay time constant has the decay of the laser pulse subtracted because the latter is about 15 ns and cannot be neglected. The experimental values almost lie on a straight line of the slope -1 , and thus suggest that collisional de-excitation causes the fast decay in the fluorescence

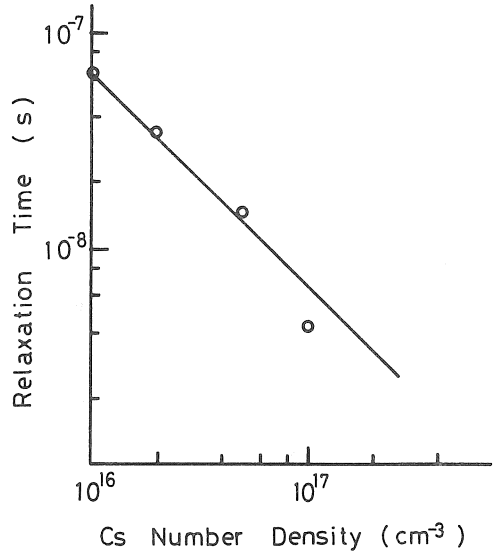

Fig.5 Relaxation time in spike of fluorescence
 $5D_{5/2}-5F_{5/2}$; $I=4.1 \times 10^7 \text{W/cm}^2$

spike. In fact, the decay time constant by the electron collision de-excitation is 50 ns at the Cs density of 10^{16}cm^{-3} using the de-excitation rate of $1.0 \times 10^{-7} \text{s}^{-1} \text{cm}^3$ ⁷⁾ ($T_e=0.2 \text{eV}$); while the time constant by the spontaneous emission is 10^{-6}s . Hence the strong population inversion on the 9S state quickly relaxes to other states.

On the other hand, as the ionization energy of the 9S state is 0.55 eV, the ionization frequency of the 9S atom by the electron collision either directly or via cascades through the higher excited states is very high. In fact, it is 10^9s^{-1} ⁸⁾ at the 9S population of $3.2 \times 10^{15} \text{cm}^{-3}$.

We observed a line shape of the atomic fluorescence and hence estimated the electron density from the Stark broadening of $5D_{5/2} - 5F_{5/2}$ transition. The time history of the observed electron density is shown in Fig. 6. At the time of the peak in the fluorescence signal, most of the electrons have not yet been produced. The electron density reaches a maximum roughly at the termination of the laser pulse. The electron density at the spike is of the order of the Cs molecular density at most, and has only a weak laser intensity dependence. Since the pulse width of the laser is shorter than the inverse of the electron collisional excitation frequency from 6S to 6P at the low Cs density, enough Cs (6P) atoms are not produced by the electron collisions for a large resonance effect in the electron density to be expected. However, the excitation time from 6S to 6P becomes comparable to the laser pulse width at the higher Cs density of 10^{17}cm^{-3} as the collisional excitation rate is then estimated to be $1.2 \times 10^{-9} \text{s}^{-1} \text{cm}^{-3}$ at $T_e=0.2 \text{eV}$.⁷⁾

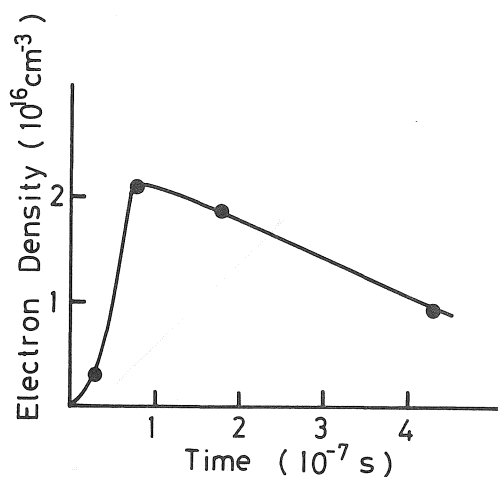

Fig.6 Time history in electron density;
 $N_{Cs} = 2 \times 10^{17} \text{ cm}^{-3}$

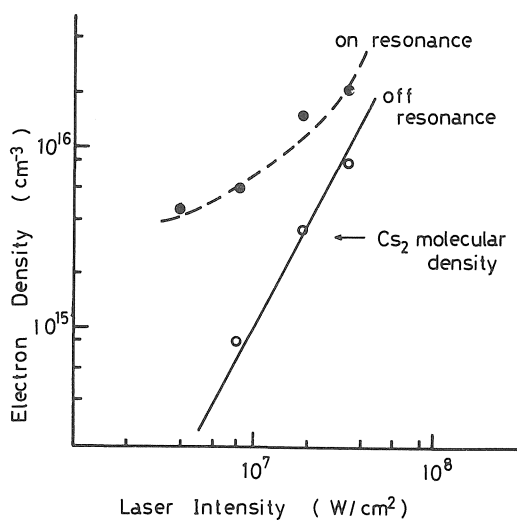

Fig.8 Electron density versus laser intensity

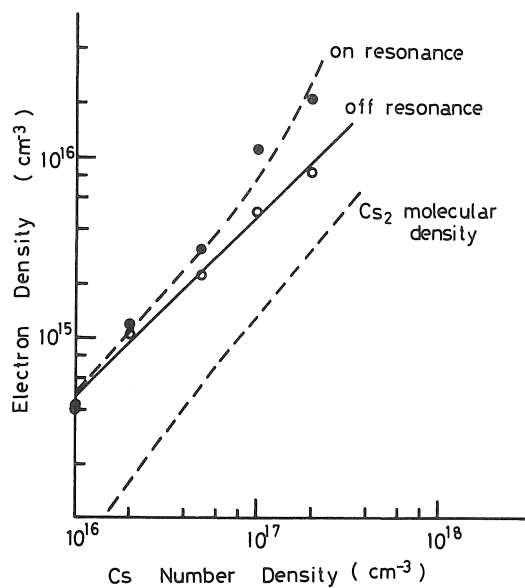

Fig.7 Electron density versus Cs number density

The electron density at the termination of the laser pulse is plotted against the Cs density for both on and off resonance illumination in Fig. 7. The electron density off resonance is proportional to the Cs density while the increment of the electron density on resonance increases at the higher Cs density above 10^{17} cm^{-3} because a lot of the Cs (6P) atoms are produced by electron collisional excitation from the ground state. At the low Cs density, the difference of the electron density between on and off resonance illumination seems to be equal to the Cs molecular density.

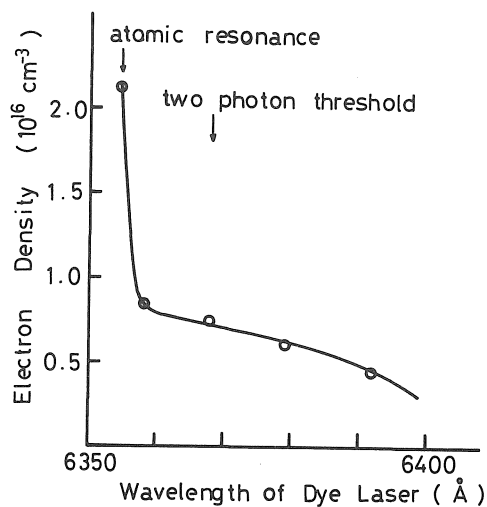

Fig.9 Wavelength dependence on electron density

The laser intensity dependence of the electron density is shown in Fig. 8 at the Cs density of $2 \times 10^{17} \text{ cm}^{-3}$. For on resonance illumination, the electron density is roughly proportional to the laser intensity at the high intensity. However, it seems that at the low intensity there is a lower limit equal to the molecular density. It must of course decrease below the molecular density at the very low intensities.

For off resonance illumination, the experimental values of the electron density lie on a straight line of the slope 2. This clearly means that two-photon ionization plays a dominant role for off resonance. But, the electron density calculated from the Bebb two-photon ionization probability²⁾ is less than the observed one, although the intensity of our laser far

Table.1 Two-photon ionization probability ω , absorption cross section for Cs_2 α and electron temperature T_e .

Wavelength	ω	α	T_e
6350 Å	$7 \times 10^{-49} \text{ F}^2$	0.63 Å^2	0.2 eV
5300 Å	$1 \times 10^{-49} \text{ F}^2$	0.01 Å^2	0.8 eV

exceeded the two-photon ionization threshold intensity.⁹ The Cs molecules or atomic excited levels may cause such a discrepancy.

The dependence of the electron density on the wavelength of the dye laser is shown in Fig. 9. A strong wavelength dependence is not found except around the atomic resonance 6354 Å. A significant ionization is still produced even at the longer wavelength beyond the two-photon ionization threshold, though the electron density decreases as the wavelength increases.

This is reasonably explained by an ionization potential depression due to the average plasma electric field. The depressed ionization potential is estimated to be 0.02 eV¹⁰ for the electron density of $2 \times 10^{15} \text{ cm}^{-3}$. It corresponds with the two-photon ionization threshold wavelength of 6400 Å, which agrees with the observed one.

We tried to produce a plasma using a green laser light, second harmonic of a glass laser (5300 Å), at which the absorption cross section of the Cs_2 has a window in the absorption band. The intensity needed to produce a plasma with comparable electron density was found to be about 3 times higher for the green laser than that for the red laser. The two-photon ionization probability ω and the absorption cross section α for red and green laser are shown in Table 1.

The absorption cross section for red laser light is 63 times larger than that for green laser light, while the two-photon ionization probability is only 7 times larger for the same photon flux. If the Cs molecular plays an important role in the ionization mechanism, the green laser should be far less efficient at producing ionization. The electron temperature experimentally observed from the atomic line intensity ratio is also shown in Table 1. As the wavelength of the red laser is near the threshold for two-photon ionization, a lower electron temperature is obtained. However, the electron temperature observed using the green laser is not only higher but is roughly equal to the energy that expected for two-photon ionization (i.e. the Cs ionization potential being subtracted from twice the photon energy).

§ 4. Conclusion

A dense Cs metal vapour was irradiated by a dye laser with the maximum power of 500 KW and the half width of 20 ns, and the ionization mechanism of the laser-induced dense Cs plasma has been investigated.

For the high Cs density with on resonance illumination, the initial production of seed electrons is presumably due to that the Cs_2 absorbs the laser photon and is excited to a repulsive Cs_2^* state which dissociates and produces Cs (6P) atom. The Cs (6P) atom absorbs the further laser photon and is hence excited to the 9S state. The Cs (9S) atoms are then quickly ionized by electron collisions. The initial electron may be supplied by a two-photon ionization because the time necessary to produce one electron by two-photon ionization is within 10^{-21} s. Electrons produced from the Cs_2 collide with Cs (6S) atom and excite to the 6P state. These Cs (6P) atoms are quickly excited to the 9S state and ionized. We did not identify the ionization process from the 9S excited state. But the process producing the 6P excited atom is the most important ones in the ionization mechanism of these plasma. The 6P excited atom plays a dominant role in our plasma as the transport phenomena in other Cs plasma.¹¹

At the low Cs density, the electron does not have enough time to produce a number of the Cs (6P) atoms. Then the two-photon ionization seems to be the main ionization route. But there remains a significant discrepancy between the theoretical and experimental values.

References

- 1) R. M. Measures: *Applied Optics* **18** (1979) 1824.
- 2) H. B. Bebb: *Phys. Rev.* **149** (1966) 25, **153** (1967) 23.
- 3) Van Hellfield et al: *J. Phys. Rev. Lett.* **40** (1978) 1376.
- 4) A. C. Tam & W. Happer: *Optics Commu.* **21** (1977) 403.
- 5) M. Lapp & L. P. Harris: *J. Quant. Spect. Radiat. Trans.* **3** (1966) 169.
- 6) P. M. Stone: *Phys. Rev.* **127** (1962) 1151.
- 7) C. Park: *J. Quant. Spect. Radiat. Trans.* **11** (1971) 7.
- 8) M. Gryzinski: *Phys. Rev.* **138** (1965) 336.
- 9) K. Kishi et al: *J. Phys. Society of Japan* **29** (1970) 1053.
- 10) J. C. Stewart & K. D. Pyatt: *Appl. J.* **144** (1966) 1203, A. A. Likal'ter: *Sov. Phys. Dokl* **26** (1981) 676.
- 11) J. Yamada & T. Okuda: *Japan. J. Appl. Phys.* **11** (1972) 1032.

(Received January 30, 1985)