

A Study on
Mathematical Marketing Models
of
Consumer Behavior

January 2002

Kazuyuki Teramoto

**A Study on
Mathematical Marketing Models
of
Consumer Behavior**

**by
Kazuyuki Teramoto**

Dissertation submitted in partial fulfillment
for the degree of Doctor of Engineering

Under the supervision of
Professor Toshio Nakagawa

Department of Industrial Engineering,
Aichi Institute of Technology
Toyota, Japan

January 2002

Abstract

It has become very difficult to sell new products on the market owing to the world-wide economic depression. This is mainly because the market has become rapidly complex and diverse by the great changes of modern society and new generation. It has become very important to plan and develop new products which reflect the sense of the times and answer to consumers' sense of values. The development of new products has to be made by knowing both consumers' needs and selection behavior. For this purpose, it is necessary to collect the data widely from consumers and to analyze them statistically and scientifically. Moreover, it is also important to study the theoretical methodology of marketing research.

This thesis utilizes five models to comprehend and analyze consumers' needs and behavior:

1. Markov Model
2. Preference Model
3. Entropy Model and Hermiter Model
4. Perception Positioning
5. Conjoint Analysis

The above five models would contribute effectively to the predictions of consumers' needs and behavior for new products, future market structure and share. By such kinds of knowledge, manufactures or companies could have good opportunities to market new products.

Finally, the results derived from this thesis are summarized and future studies are described.

Acknowledgement

The author wishes to appreciate Toshio Nakagawa, the supervisor of this thesis, for his kind coaching, continual encouragement and valuable suggestions throughout this work.

The author wishes to thank the members of this thesis reviewing committee: Professor Shigenobu Nomura, Professor Takayoshi Tamura and Professor Kazumi Yasui for their careful reviewing of this dissertation.

The author is also grateful to Professor Shunji Osaki of Nanzan University and Professor Hiroaki Sandoh of University of Marketing and Distribution Science for having presented the papers at some national conferences and their useful comments, and wishes to thank all members of Nagoya Computer and Reliability Research Group.

Furthermore, the author's thanks are to all members of Department of Industrial Engineering, Aichi Institute of Technology, especially to Professor Tetsuhisa Oda.

Finally, I would like to thank my family for the mental and spiritual support and waiting in quiet patience for finishing the work.

Contents

Chapter 1	Introduction	1
1.1	Review of literatures	2
1.2	Organization of thesis.....	4
Chapter 2	Transition Model of Market Share on Markov Process	7
2.1	Introduction.....	8
2.2	Transition probability matrix.....	8
2.3	Calculus of transition probabilities.....	10
2.4	Conclusions	17
Chapter 3	Estimation of Purchase Probability on Preference Models.....	19
3.1	Introduction.....	20
3.2	Preference model.....	21
3.3	Market share	23
3.4	Simulations	26
3.5	Conclusions	34
Chapter 4	Stratified Analysis of Preferences on New Products.....	39
4.1	Introduction.....	40
4.2	Results of questionnaire.....	41
4.3	Herniter model.....	44
4.4	Conclusions	49

Chapter 5	Perceptual Positioning of Products on Discriminant Analysis	51
5.1	Introduction.....	52
5.2	Method.....	52
5.3	Results.....	59
5.4	Conclusions.....	61
Chapter 6	Perceptual Positioning of Products on Principal Component Analysis	63
6.1	Introduction.....	64
6.2	Method.....	64
6.3	Results.....	66
6.4	Conclusions	69
Chapter 7	Optimal Product-Planning for New Products on Conjoint Analysis	71
7.1	Introduction.....	72
7.2	Selection of attributes.....	73
7.3	Application of conjoint analysis	74
7.4	Calculation of contribution rate	76
7.5	Results of analysis.....	76
7.6	Conclusions	81
Chapter 8	Conclusions.....	83

List of Tables

2.1	Domestic beer market share for past 11 years (%)	10
3.1	Summary results of factor analysis on the brand attribute measure	27
3.2	Brand positioning	28
3.3	Preference rate	28
3.4	Ideal point	30
3.5	Purchase probability (P_g), distance between an ideal point and brand positioning (d), and estimated purchase probability (\hat{p}_g) for each brand (males).....	31
3.6	Purchase probability (P_g), distance between an ideal point and brand positioning (d), and estimated purchase probability (\hat{p}_g) for each brand (females)	31
3.7	Numerical summary of parameters to estimate market shares	33
3.8	Market shares	34
4.1	Market shares of perfume in Japan	42
4.2	Market shares of factors	43
4.3	Transition probabilities p_{ij}	49
5.1	Questionnaire	54
5.2	Attribute correlations	55
5.3	Correlation coefficient	58
5.4	Centroid of composite variation	60
6.1	Component loading of 4 companies	67

6.2	Principal component score of 4 companies	68
6.3	Prediction of market shares and actual comparison of 4 companies.....	68
7.1	Part worth of cup ramen	78
7.2	Ratio of contribution	79
7.3	Attribute and level of cup ramen	79
7.4	Orthogonal design of cup ramen	80
7.5	Optimal plan	81

List of Figures

2.1	Transition of market share	16
3.1	Flow chart of preference model	21
3.2	Joint space for males	29
3.3	Joint space for females	29
4.1	Tree of Hermiter model	47
5.1	Flow chart of analysis	53
5.2	Positioning of composite variation	59
5.3	Positioning map of soft drink	60
5.4	Positioning map of variable benefit	61
6.1	Figure of scatter	67
7.1	Flow chart of conjoint analysis	74
7.2	Part worth of attribute i ($i = 1, 2, 3$)	75

Chapter 1

Introduction

In the present economic situation of the world, it has become increasingly difficult for most companies to stay afloat. The market has been over-saturated with similar products, and thus, it has become important to think and predict how to stir up the great interest in consumers. Also, the economy in many countries has fallen into stagnation or recession. As the result, consumers have less money for spending, and have become more sensitive to selection of their purchases.

The main objective of the thesis is to help companies with the process of providing new products to the market. There are many methods to investigate consumers' needs and behavior from the development of products to their selling. The most important problem which companies are facing is to find out what kinds of products will be sold on the market. There are several methods of approaching toward such problems. The following five techniques are utilized in this thesis:

1. Using a Markov chain, the brand loyalty of consumers is analyzed. The transition probabilities from one brand to another are calculated and the future shares of brands are predicted.

2. In order to find out consumers' preferences and to hit their target correctly, the preference model is used.
3. For further discernment of consumers' preferences, the entropy model in information theory and the Herniter model are used.
4. From consumers' surveys and ratings, the degree of preferences for different products is deduced. Using the perception positioning method, the opportunity for the development of new products is analyzed.
5. Using the conjoint analysis, the final concept of an optimal product is given.

1.1 Review of literatures

In this section, we summarize the results of typical mathematical marketing models: The main purpose of marketing strategies is to acquire consumers who are loyal. In this thesis, using the methods of probability and statistical theories, we analyze the ratio of consumers who maintain loyalty to particular brands, and the ratio of consumers who have no particular brand loyalty. Until now, there have been done several studies on consumers' behavior, using Markov processes (Ross (1970)). Styan and Smith (1964) studied the switching of consumers' preference from powder soap to synthetic detergent, and calculated the matrix of transition probabilities to find out the consumers' behavior. Further, Theil and Rey (1966) analyzed the change in consumers' loyalty regarding American cigarettes. The prediction of market share in the near future can be relatively accurated, using the transition probabilities, however, it would be very difficult to give it in the more distant future.

At the present, the following marketing models have been suggested:

- (1) Linear learning model based on developing consumers' experience (Kuehn (1961)).
- (2) Model including the effects of price and advertisement (Lipstein (1965)).

- (3) Markov model including the linear learning model and the marketing variable of a company (Kuehn (1964)).
- (4) Model in which consumers are divided into those loyally to a particular brand and are switched between several brands (Colombo and Morrison (1989)).

We mention briefly the above models: The fundamental concept of a preference model is that *consumers select their favorite brands by the degree of their preferences* (Muto (1986)). Purchase probabilities of each brand based on such concept is estimated and calculated, using the preference data from consumers. An *evoked set* (Urban (1980)) in the model is a set of names of brands which come immediately to consumers' mind when they want to purchase a product. From the data obtained by chip games, the constant-sum method of Comrey is applied to the calculation of preference rates of each brand (Muto (1986)), and the matrix of preference rates of m brands for n consumers is computed. Further, power transformation centroid method is used to obtain an ideal point of consumers' preferences in a multi-dimensional space (Asano (1990)). From this method, the matrix of coordinates of m brands in the r -dimensional space is also computed. Finally, by combining the above two methods, an ideal point of preferences of n consumers in the r -dimensional space is obtained.

The entropy model has been considered in many fields of marketing science and applied to the studies of share prediction and evaluation of selection probabilities. Using the algorithm and maximum entropy principle in information theory, Gensch (1995) evaluated the selection probability and examined the marketing structure. Brockett (1995) investigated the effectiveness of information theory as a statistical approach to use in marketing research, and applied it to the logarithm linear model, entropy model, logit model and brand switching model. Ito (1987) calculated the weight ratio of several factors for women's preferences in fashion, using the entropy model. Using this model, Herniter (1973) divided consumers into two strata; the non-fixed stratum of those who have not decided their purchases, and the fixed

stratum of those who purchase only one brand, and explained the market structure of the non-fixed stratum by calculating the stratum ratio. This has greatly developed the theory of demand for consumers.

We take out a different image or a product concept of consumers and make the perception positioning: Consumers evaluate products and have a product concept of some attributes. Using the technique of factor analysis, we can gather information of manufacturing auto protocol in two or three dimensions (Urban, et al. (1987), and Urban and Hauser (1993)). The conjoint analysis, which is one of the marketing research techniques, is mainly used in such a situation. Using the orthogonal array, the preferences of consumers are analyzed, and the levels of preferences for some attribute (e.g., taste, size, price) are measured. Further, several product plans, including different levels of attributes, are proposed by Katahira (1987).

1.2 Organization of thesis

This section describes the organization of this thesis. This thesis is divided into Introduction, Chapters 2-7, Conclusions and Bibliography.

Firstly, we consider a transition model of market shares on a Markov process in Chapter 2. A Markov process, which is the most basic stochastic process, has been applied to various problems such as social movements, demand predictions, income distributions, stock price predictions, and reliability models. This chapter, using a Markov chain, estimates future market shares of 4 Japanese beer companies.

Chapter 3 estimates the marketing opportunity rate of a new product, using the preference model. This is one of the important prediction methods to study the market of a new product and to minimize the risk of its development project. To test this method, provided that

BLENDY of AGF Company is put into the market, 6 kinds of canned coffee sold in Japan are investigated through questionnaires. Using the technique of brand positioning based on the factor analysis, their marketing shares are estimated and a purchase probability of *BLENDY* is computed.

Chapter 4 makes the analysis of the market share structure of perfumes for young women, using the Hermiter model. Preferences in 4 factors of the selected kinds of perfumes are analyzed (e.g., fragrance, price, design, name). The factors of preferences for each item are investigated on the market, and then, by applying collected data to the entropy model, their rates are numerically obtained. It is shown that more than 70% of consumers have already decided a factor of preferences for their favorite brand. Further, there are two groups of consumers; one selects according to only one factor of preferences and the other selects according to several factors.

Chapter 5 gives the example in which the discriminant analysis and principal component analysis to do perception positioning are used: When a new product will be developed and launched into the market, it is very essential to investigate and know the market structure and the competitor's positioning. A new product has to be placed on the market area which is not fully occupied by existing competitors. This chapter takes up the business of soft drink which has rushed into an age of keen competition: The perceptual data which ask the benefit of 10 soft drinks are collected from questionnaires. The correlation and discriminant analysis are made from these data and the diagram of positioning of soft drinks on the market is drawn. We discuss useful market strategies to plan what kinds of new soft drinks should be put on the market.

Chapter 6 takes up the business of cellular phone which has rushed rapidly into an age of keen competition: The perceptual data which ask the benefit of 4 kinds of cellular phone are collected from questionnaires. The correlation and principal component analyses are made from these data, and the diagram of positioning of cellular phone on the market is drawn. We discuss useful market strategies to plan what kinds of new cellular phone should be put on the market.

In Chapter 7, while designing a new product, it is vital to grasp consumers' evaluation of the present products. It is crucial for the product experimental design to clarify the degree of consumers and preferences of the product's attributes. The conjoint analysis, which is one of the marketing research techniques, is mainly used in such a situation. We take up cupramen as an example, which becomes enormously popular. Using the orthogonal array, the preferences of consumers are analyzed, and the levels of preferences for some attributes (e.g., taste, size, price) are measured. Next, several product plans, including different levels of attributes, are proposed. Optimal products both for males and females are presented as a result.

Finally, Chapter 8 summarizes the results derived in this thesis and states briefly several remaining and future problems to be solved.

Chapter 2

Transition Model of Market Share on Markov Process

In this rapidly developing modern society, it would be impossible to predict the future completely and accurately. However, using the probability theory from the present and the past data, we could predict the future to a certain degree. There are many cases where the probability theory is used in daily life. For example, there are manpower plan and promotion models that handle the promotion of company employees. Also, if a company wants to predict the sale of a product, it takes into consideration the sales data collected until the present, and then, using the probability theory, it needs to predict what the sales of that product will change for several years.

The probability theory is now used in various places. A Markov process, which is the most basic stochastic process, is applied in various problems such as social movements, demand prediction, income distribution, stock price prediction, and reliability models. This chapter, using a Markov chain, estimates future market shares of 4 Japanese beer companies.

2.1 Introduction

The main purpose of marketing strategy is to acquire consumers who are loyal. In this chapter, using the method of probability, we try to analyze the ratio of consumers who maintain loyalty to particular brands, and the ratio of consumers with no particular brand loyalty. Until now, there have been done several studies on consumers' behavior, using a Markov chain. Styan and Smith (1964) studied on the switching of consumers' preference from powder soap to synthetic detergent. They also calculated the matrix of transition probabilities to find out consumers' behavior. Theil and Rey (1966) analyzed the change of consumers' loyalty regarding American cigarettes. The most effective plan should be used in marketing strategies.

This chapter, using a Markov chain, estimates future market shares of 4 Japanese beer companies.

2.2 Transition probability matrix

We compute a transition probability matrix from the collected data of the present market share, and then, estimate the future share. It is denoted that y_{it} is the market share of company i ($i = 1, 2, \dots, s$) at time t ($t = 0, 1, 2, \dots, T$) and $p_{ij}(t)$ is the probability that a consumer transits into company j at time $t + 1$ when he / she purchased products of company i at time t . However, since the transition probability $p_{ij}(t)$ is changed little for time t , it is assumed that $p_{ij} \equiv p_{ij}(t)$ for all t .

Let \mathbf{y}_t be a probability vector of y_{it} and \mathbf{P} be a transition probability matrix of p_{ij} ,

i.e.,

$$\mathbf{y}_t \equiv (y_{t1}, y_{t2}, \dots, y_{ts}),$$

$$\mathbf{P} = \begin{pmatrix} p_{11} & p_{12} & \cdots & p_{1s} \\ p_{21} & p_{22} & \cdots & p_{2s} \\ \vdots & \vdots & \ddots & \vdots \\ p_{s1} & p_{s2} & \cdots & p_{ss} \end{pmatrix},$$

where $\sum_{i=1}^s y_{ti} = 1$ and $\sum_{j=1}^s p_{ij} = 1$.

Then, assuming that the market share forms a Markov chain, we have

$$\mathbf{y}_t = \mathbf{y}_{t-1} \mathbf{P} \quad (t = 1, 2, \dots, T). \quad (2.1)$$

Thus, if the transition probability p_{ij} would be accurately estimated, we could get a good estimation of y_{ti} .

There are several methods of calculating \mathbf{y}_t . In this chapter, we calculate the sum of the 2nd power of each factor in $\mathbf{y}_t - \mathbf{y}_{t-1} \mathbf{P}$ and minimize it. That is, we decide p_{ij} which minimizes

$$\sum_{t=1}^T \sum_{j=1}^s \left(y_{tj} - \sum_{i=0}^s y_{t-1i} p_{ij} \right)^2. \quad (2.2)$$

Differentiating (2.2) with respect to p_{ij} and setting it equal to zero, we have

$$\sum_{i=1}^T y_{t-1i} y_{ij} = \sum_{k=1}^s \left(\sum_{i=1}^T y_{t-1i} y_{t-1k} \right) p_{kj}. \quad (2.3)$$

Letting $\mathbf{Y} \equiv \left(\sum_{i=1}^T y_{t-1i} y_{ij} \right)$ and $\mathbf{Z} \equiv \left(\sum_{i=1}^T y_{t-1i} y_{t-1k} \right)$, equation (2.3) is rewritten as $\mathbf{Y} = \mathbf{ZP}$.

Thus, the transition probability can be estimated by

$$\hat{\mathbf{P}} = \mathbf{Z}^{-1} \mathbf{Y}. \quad (2.4)$$

2.3 Calculus of transition probabilities

We give the market shares of 4 domestic beers for 11 years from 1981 to 1991 in Table 2.1, and calculate the transition probability from (2.4) as follows:

Table 2.1 Domestic beer market share for past 11 years (%)

	Kirin	Asahi	Sapporo	Suntory
1981	62.9	10.4	20.0	6.7
1982	62.4	9.9	19.9	7.8
1983	61.4	10.2	19.9	8.5
1984	61.7	9.8	19.7	8.8
1985	61.4	9.6	19.8	9.2
1986	59.7	10.4	20.7	9.2
1987	57.1	12.9	20.5	9.5
1988	50.8	20.6	19.8	8.8
1989	48.1	25.0	18.5	8.4
1990	49.2	24.7	18.0	8.1
1991	49.9	24.1	18.2	7.8

From Table 2.1,

$$\mathbf{Y} = \begin{pmatrix} 3.2573 & 0.8682 & 1.1251 & 0.4964 \\ 0.7764 & 0.2625 & 0.2747 & 0.1214 \\ 1.1073 & 0.3066 & 0.3813 & 0.1697 \\ 0.4760 & 0.1346 & 0.1659 & 0.0735 \end{pmatrix}, \quad \mathbf{Z} = \begin{pmatrix} 3.3336 & 0.7914 & 1.1340 & 0.4879 \\ 0.7914 & 0.2432 & 0.2786 & 0.1218 \\ 1.1340 & 0.2786 & 0.3879 & 0.1675 \\ 0.4879 & 0.1218 & 0.1675 & 0.0729 \end{pmatrix}$$

i.e.,

$$\mathbf{Z}^{-1} = \begin{pmatrix} 207.0941 & 99.1109 & -815.2431 & 321.1821 \\ 99.1109 & 72.9750 & -379.2519 & 85.9510 \\ -805.2431 & -379.2519 & 3542.1375 & -2047.6445 \\ 321.1821 & 85.9510 & -2047.6445 & 2425.4011 \end{pmatrix}$$

Thus, from (2.3), we have

$$\hat{\mathbf{P}} = \begin{pmatrix} 1.6333 & -0.8988 & 0.2007 & 0.0648 \\ 0.4374 & 0.4967 & 0.0638 & 0.0021 \\ -2.1836 & 2.9991 & 0.1982 & -0.0137 \\ -0.1173 & 0.1442 & 0.3705 & 0.6026 \end{pmatrix}. \quad (2.5)$$

However, there are 4 negative factors in $\hat{\mathbf{P}}$, and so that, we cannot estimate transition probabilities. We need to consider the method by which no negative factors come out.

The values of factors which become negative will be small even if they are 0 or positive. Looking from this viewpoint, we consider the following method of losing negative factors:

- (1) We calculate $\hat{\mathbf{P}}_0 = \mathbf{Z}^{-1}\mathbf{Y}$.
- (2) If there are negative factors in $\hat{\mathbf{P}}_0$, then we select the maximum in the absolute values of negative factors and put it equal to 0, i.e., $p_{3l} = 0$ in (2.5).

If there is no negative factor in $\hat{\mathbf{P}}_1$, then $\hat{\mathbf{P}}_1$ is adopted as the estimation of a transition probability matrix. If there are still negative factors in $\hat{\mathbf{P}}_1$, then we select the maximum in the absolute value of negative factors and put them equal to zero. We continue such procedures until there is no negative factor. In this case, the sum of each row in (2.2) might not be equal to 1. so that, we must take out the condition of $\sum_{j=1}^s p_{ij} = 1$ at any time when we minimize \mathbf{y}_t .

When a set J with status number (k, h) was given, we may compute $\mathbf{P} = (p_{ij})$ which minimize equation (2.2) under the conditions of

$$p_{kh}=0, \quad (k, h) \in J, \quad (2.6)$$

and

$$\sum_{j=1}^s p_{ij} = 1 \quad (i = 1, 2, \dots, s). \quad (2.7)$$

In this case, it is effective to use the method of undetermined multipliers of Lagrange: Let λ_i and μ_{kh} be Lagrange multipliers of condition (2.6) and (2.7), respectively. Then, from (2.2), (2.6) and (2.7), we easily have

$$\begin{aligned} & \sum_{t=1}^T \sum_{j=1}^s \left(y_{ij} - \sum_{i=1}^s y_{t-1,i} p_{ij} \right)^2 + \sum_{i=1}^s \lambda_i \left(\sum_{j=1}^s p_{ij} - 1 \right) + \sum_{(k,h) \in J} \mu_{kh} p_{kh} . \\ & \sum_{t=1}^T y_{t-1,i} y_{t,j} - \sum_{k=1}^s (y_{t-1,j}) p_{kj} = \begin{cases} \lambda_i & \text{for } (i, j) \notin J, \\ \lambda_i + \mu_{ij} & \text{for } (i, j) \in J. \end{cases} \end{aligned} \quad (2.8)$$

Next, we express (2.8) in a matrix form. Let λ be a column vector with λ_i for factor i , ξ be a column vector with all 1 and \mathbf{U} be as follows:

$$\mathbf{U} = (u_{ij}) = \begin{cases} \mu_{ij} & \text{for } (i, j) \neq J, \\ 0 & \text{for } (i, j) = J. \end{cases} \quad (2.9)$$

Then, equation (2.8) is expressed as

$$\mathbf{Y} - \mathbf{ZP} = \lambda \xi^T + \mathbf{U}. \quad (2.10)$$

Multiplying ξ from the right in (2.10), we have

$$\lambda = -\frac{1}{s} \mathbf{U} \xi,$$

since the left-hand side is 0. Therefore, we have

$$\mathbf{P} = \mathbf{Z}^{-1} \left(\mathbf{Y} + \frac{1}{s} \mathbf{U} \xi \xi^T - \mathbf{U} \right). \quad (2.11)$$

Since $p_{ij} = 0$ for $(i, j) \in J$, we can derive only the equations of μ_{ij} for $(i, j) \in J$, by rewriting (2.10) and pulling it into order for every factors (i, j) . Thus, we can calculate p_{ij} from (2.10), using the values of μ_{ij} .

We have put that $p_{31} = 0$, however, we cannot vanish negative factors in the matrix. Further, we put that $p_{12} = p_{31} = p_{34} = p_{41} = 0$, and seek transition probabilities which minimize (2.2). Then, the term of \mathbf{U} in the right side of (2.11) is expressed as

$$\begin{aligned} \frac{1}{4} \mathbf{U} \xi \xi^T - \mathbf{U} &= \frac{1}{4} \begin{pmatrix} \mu_{12} & \mu_{12} & \mu_{12} & \mu_{12} \\ 0 & 0 & 0 & 0 \\ \mu_{31} + \mu_{34} & \mu_{31} + \mu_{34} & \mu_{31} + \mu_{34} & \mu_{31} + \mu_{34} \\ \mu_{41} & \mu_{41} & \mu_{41} & \mu_{41} \end{pmatrix} - \begin{pmatrix} 0 & \mu_{12} & 0 & 0 \\ 0 & 0 & 0 & 0 \\ \mu_{31} & 0 & 0 & \mu_{34} \\ \mu_{41} & 0 & 0 & 0 \end{pmatrix} \\ &= \frac{1}{4} \begin{pmatrix} \mu_{12} & -3\mu_{12} & \mu_{12} & \mu_{12} \\ 0 & 0 & 0 & 0 \\ -3\mu_{31} + \mu_{34} & \mu_{31} + \mu_{34} & \mu_{31} + \mu_{34} & \mu_{31} - 3\mu_{34} \\ -3\mu_{41} & \mu_{41} & \mu_{41} & \mu_{41} \end{pmatrix}. \end{aligned}$$

Hence, equations for μ_{12} , μ_{31} , μ_{34} and μ_{41} are given by

$$0 = p_{12} + \frac{1}{4} \{ z^{-1}_{11}(-3\mu_{12}) + z^{-1}_{12} \times 0 + z^{-1}_{13}(\mu_{31} + \mu_{34}) + z^{-1}_{14}\mu_{41} \},$$

$$0 = p_{31} + \frac{1}{4} \{ z^{-1}_{31}3\mu_{12} + z^{-1}_{32} \times 0 + z^{-1}_{33}(-3\mu_{31} + \mu_{34}) + z^{-1}_{34}(-3\mu_{41}) \},$$

$$0 = p_{34} + \frac{1}{4} \{ z^{-1}_{31}\mu_{12} + z^{-1}_{32} \times 0 + z^{-1}_{33}(\mu_{31} - 3\mu_{34}) + z^{-1}_{34}\mu_{41} \},$$

$$0 = p_{41} + \frac{1}{4} \{ z^{-1}_{41}\mu_{12} + z^{-1}_{42} \times 0 + z^{-1}_{43}(-3\mu_{31} + \mu_{34}) + z^{-1}_{44}(-3\mu_{41}) \}.$$

Substituting p_{ij} and z^{-l}_{ij} into the above equations,

$$0 = -0.8988 + \frac{1}{4} \{207.0941(-3 \mu_{12}) - 815.2431(\mu_{31} + \mu_{34}) + 321.1821 \mu_{41}\},$$

$$0 = -2.1836 + \frac{1}{4} \{-815.24313 \mu_{12} + 3542.1375(-3 \mu_{31} + \mu_{34}) - 2047.6445(-3 \mu_{41})\},$$

$$0 = -0.0137 + \frac{1}{4} \{-815.2431 \mu_{12} + 3542.1375(\mu_{31} - 3 \mu_{34}) - 2047.6445 \mu_{41}\},$$

$$0 = -0.1173 + \frac{1}{4} \{321.1821 \mu_{12} + 85.9510(-3 \mu_{31} + \mu_{34}) + 2425.4011(-3 \mu_{41})\}.$$

Solving these equations, we have that $\mu_{12} = -5.5226 \times 10^{-3}$, $\mu_{31} = -1.0189 \times 10^{-3}$, $\mu_{34} = 3.2152 \times 10^{-4}$ and $\mu_{41} = -1.2589 \times 10^{-3}$.

There exist still negative factors in \mathbf{P} . We put again that $p_{13} = p_{23} = p_{32} = p_{43} = 0$, and repeat the above calculations until all negative factors have vanished out of \mathbf{P} . Consequently, a transition probability matrix is estimated as follows:

$$\hat{\mathbf{P}} = \begin{pmatrix} 0.9343 & 0.0000 & 0.0000 & 0.0657 \\ 0.0356 & 0.9528 & 0.0000 & 0.0116 \\ 0.0000 & 0.0000 & 0.9894 & 0.0106 \\ 0.2300 & 0.2503 & 0.0000 & 0.5197 \end{pmatrix}$$

i.e., the transition probability matrix of each company is

	Kirin	Asahi	Sapporo	Suntory	
Kirin	(0.9343	0.0000	0.0000	0.0657
Asahi		0.0356	0.9528	0.0000	0.0116
Sapporo		0.0000	0.0000	0.9894	0.0106
Suntory		0.2300	0.2503	0.0000	0.5197

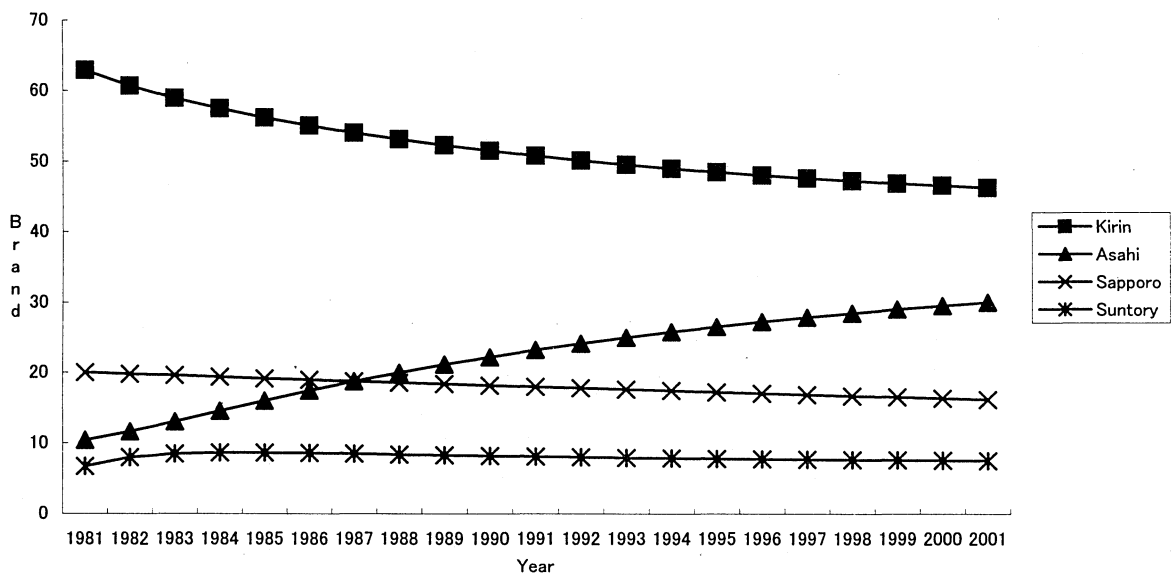

Figure 2.1 Transition of market share

2.4 Conclusions

Using the market share of 4 beer markets in 1981, we have calculated the transition probability and estimated their market shares from 1982 to 2001 in Figure 2.1. This indicates that Kirin would decrease gradually from 62.9% to 46.3%, and conversely, Asahi would increase greatly 10.4% to 30.0%. Sapporo also would decrease slowly from 20.0% to 16.2%, however, its range is small. Suntory would increase from 6.7% to 8.1% in 1986, and after that, decrease to 7.5%.

Comparing these estimated values with their real data of shares, we can predict well the shares until 1991. However, it would be very difficult to give the prediction for a long time. At present, several brand switching probability models have been developed by Colombo and Morrison (1989). Further studies for such fields would be expected.

Chapter 3

Estimation of Purchase Probability on Preference Models

This chapter estimates the marketing opportunity rate of a new product, using the preference model. This is one of the important prediction methods to study the market of a new product and to minimize the risk of its development project. To test this method, provided that *BLENDY* of AGF Company is put into the market, 6 kinds of canned coffee sold in Japan are investigated through questionnaires. Using the technique of brand positioning based on the factor analysis, their market shares are estimated and a purchase probability of *BLENDY* is computed.

3.1 Introduction

Canned coffee has been on sale in Japan for more than 30 years since UCC Company put it on the market in 1969, and continues to sell well. At present, canned coffee has the largest market share of 22.9% in soft drinks. Beer companies, in addition to the existing companies, now begin to come into the market.

The latest problem in making canned coffee is how to develop its high quality. For example, the market trend is shifting to sell *real coffee* rather than *milk coffee*, and *190cc volume* rather than *250cc volume*. Each company tries to make clear remarkable differences between their products and others. Thus, many kinds of canned coffee are now on sale.

About the 70-80 percent of canned coffee are sold through vending machines. One reason that Coca-Cola has become a top company is that this company has succeeded in forming a wide network of more than 700,000 vending machines on the market. The increment of vending machines implies the market in soft drinks. Recently, however, there are some social problems for setting up vending machines, because they might cause obstruction to public roads. Therefore, each company has to compete with others in development of new distinguished products. Thus, it has become very important to predict the market share of a new canned coffee.

In this chapter, suppose that *BLENDY* of AGF is put into the market. Then, using the preference model, the market shares of 6 companies are computed and a purchase probability of *BLENDY* is estimated.

3.2 Preference model

The fundamental concept of a preference model is that *consumers select their favorite brands by the degree of their preferences* (Saito (1990)). Purchase probabilities of each brand based on this concept are estimated, using the preference data collected from student consumers (Urban, Hauser and Dholakia (1987)).

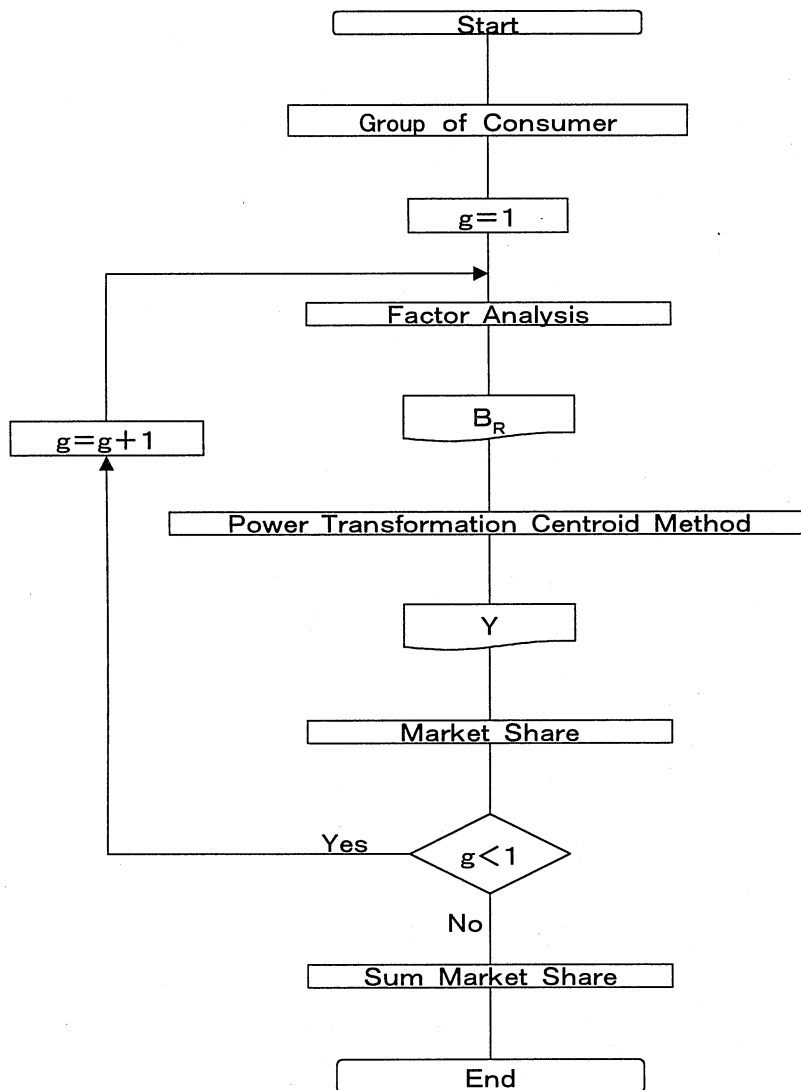

Figure 3.1

Flow chart of preference model

Figure 3.1 gives a flow chart of the preference model. The term of *evoked set* is used in the preference model with the following definition: An *evoked set* (Urban and Hauser (1980)) is a set of names of brands which come immediately to consumers' mind when they want to purchase products. The following questions are asked to respondents of the questionnaire survey:

- a) What are the names of brands which you have consumed in these days?
- b) What are the names of brands which you have purchased in these days?
- c) What are the names of brands which you have consumed the most until now?
- d) What are the names of brands which you have consumed until now?
- e) What are the names of brands which you want to purchase next time?
- f) What are the names of brands which you do not want to purchase in the future?

It is noted that all brands, which consumers have purchased or do not want to purchase, are contained in an *evoked set*.

Therefore, the research method requires that a set of two kinds of coffee at one time is compared in terms of a chip allocation exercise (Asano (1990)). There are 11 chips, each with the value of 1 point. The questionnaire respondents are asked to give chips to two brands brought to the comparison, according to their preference rates. For example, they can give 7 points for brand A and 4 points for brand B.

Based on the data obtained by chip games, the constant-sum method of Comrey (Muto (1986)) is applied to calculate preference rates of each brand. Then, (1) a matrix that represents preference rates of m brands for n consumers is computed.

Next, the power transformation centroid method (Asano (1990)) is used to obtain an ideal point of consumers' preferences in a multi-dimensional space. This method computes (2) a matrix that represents coordinates of m brands in the r -dimensional space. Finally, by

combining the above (1) and (2) matrices, an ideal point of preferences of n consumers in the r -dimensional space is given.

3.3 Market share

Using the preference model, the following procedures for estimating purchase probabilities and market shares of each brand are made (Howord & Shoth, (1960)): Firstly, questionnaires were handed out to 50 male and 50 female between student consumers from aged 19 to 22 in 1992 at the campus of Aichi Institute of Technology. Question items that sample students are asked to respond are shown in Appendix.

(1) Brand positioning map

A positioning map is a coordinate graph which shows the relationship between the mean (*ideal point*) of consumers' preferences for several items (e.g., goods, types, brands) and consumers' preferences for those items. In this chapter, the brand positioning map for canned coffee is made to show the relationship between an ideal point of consumers' preferences and several brands of coffee sold in the market. Figures 3.2 and 3.3 illustrate brand positioning maps in graphic forms for males and females, respectively.

Brand positioning maps are set up for each brand in the following way:

- (i) Matrix Xg is formed from the brand rating data in each group (g) (6 coffee brands as shown in Appendix 1), where rows represent the score of an evoked set (number of \bigcirc marks given to each brand) and columns represent the scores of attribute ratings of the brand in each group (g : male and female).

- (ii) Factor scores for each brand are obtained in order to compare 6 brands and the positioning of each brand relative to others in each group (g) is analyzed.

The matrix Xg is constructed according to the brand rating data for each group, and represents the number of evoked sets and ratings of brand attributes shown in Appendix 1 and 2.

(2) Estimation of preference rates

Preference rates of each brand are calculated from the data of the chip game, using the constant-sum method of Comrey.

(3) Ideal point

An ideal point is the one in a perception space that shows the ideal characteristic of a product. Ideal points of brands are sought in brand positioning maps, using the preference rates of corresponding brands. These points are obtained by a power transformation centroid method, where it is decided by which distances between this point and points of each brand show the preference rates of each brand. A brand positioning map with an ideal point is called a joint space and shows both perception and preference of consumers.

(4) Estimation of a purchase probability

Preference rates of purchase probabilities are transformed, using the multi-nominal logit model (Silk and Urban (1978)), i.e.,

$$p_j = \frac{e^{S_j}}{\sum_{i=1}^m e^{S_i}} \quad (j=1, 2, \dots, m), \quad (3.1)$$

where S_j is the preference rate of brand j , and S_i is the preference rate of brand i which is calculated by the chip game. The number m of brands is equal to 6 in this section. It is noted that p_j is the ratio between preference of j brand and the sum of brand preference, and indicates purchase probabilities of j brand.

Next, the distance d_{g_j} between the point b_j of brand j and an ideal point y_g in each group is obtained in a joint space:

$$\mathbf{d} = (d_{g_j}^2) = ((y_g - b_j)' (y_g - b_j)). \quad (3.2)$$

Then, assuming that purchase probabilities p_j are inversely proportional to the square sum of distances d_{g_j} , its vector is given by

$$\mathbf{P}_g \equiv (p_j) = \alpha_0 \mathbf{1} + \alpha_1 \mathbf{d} + \mathbf{e}, \quad (3.3)$$

where $\mathbf{1}$ is $m = 6$ columns vector where all elements are 1 and \mathbf{e} is a residual vector.

Therefore, when \mathbf{P}_g and \mathbf{d} are given, parameters α_0 and α_1 can be obtained by the least square method as follows:

$$\hat{\mathbf{P}}_g = \alpha_0 \mathbf{1} + \alpha_1 \mathbf{d}. \quad (3.4)$$

(5) Estimation of a market shares

From the above results, market shares (M) of each brand are given by

$$M = \frac{1}{\sum N_g U_g} \sum N_g U_g E_{gN} \hat{P}_{gN}, \quad (3.5)$$

where

N_g is a number of consumers in each sample group (male and female groups),

U_g is average consumption in each group per one consumer,

E_{gN} is a number of consumers who select each brand in an evoked set divided by the number of consumers, i.e., the probability that number of each group select each brand in an *evoked set*,

\hat{P}_{gN} is an estimated purchase probability of each brand based on members of each group.

3.4 Simulations

(1) Factor analysis of brand attributes

Factor loadings are calculated based on the principal component analysis with varimax rotation, and the summary results of the factor analysis are shown in Table 3.1 for male and female samples separately. Comparing the results of factor loadings for males and females, we can understand that attributes of fragrance and feeling are highly loaded on the first factor $f(1)$ for both males and females. However, while the bitterness factor is extremely high on $f(1)$ for males, it is very low for females in both $f(1)$ and $f(2)$. On the other hand, the after-taste for females is higher in loading on $f(1)$, while it is not so for males.

Since fragrance, feeling and aftertaste are key attributes for females in constructing the first factor $f(1)$, it can be said as the results that females drink coffee to enjoy fragrance in addition to other attributes. However, the high loading of bitterness among males on the $f(1)$ shows that males drink coffee mostly to enjoy bitterness (Isihara, et al. (1990)).

Table 3.1 Summary results of factor analysis on the brand attribute measure

Subjects :	Male ($n = 50$)			Female ($n = 50$)		
	$f(1)$	$f(2)$	h^2	$f(1)$	$f(2)$	h^2
1 Fragrance	.527	.449	.479	.755	-.060	.574
2 Sweetness	-.744	-.029	.555	.006	.859	.738
3 Bitterness	.944	-.137	.909	.125	-.817	.683
4 Mildness	.017	.432	.187	.566	.305	.413
5 Plainness	.341	.366	.250	.502	-.224	.302
6 Feeling	.575	.538	.620	.659	-.250	.497
7 Aftertaste	.285	.497	.328	.688	-.116	.487
8 Design	.455	.428	.389	.407	-.170	.195
9 Advertisement	.181	.169	.061	.238	.075	.062
10 Manufacturer	-.046	.265	.072	.435	.217	.236
Eigen value	2.491	1.359	3.850	2.478	1.709	4.187
Contribution ratio	64.7%	35.3%	100.0%	59.2%	40.8%	100.0%

$f(1)$: factor 1, $f(2)$: factor 2, h^2 : communality

(2) Brand positioning

A brand positioning can be presented as a coordinate of two factor scores $f(1)$ and $f(2)$, and be calculated by averaging factor loadings across brands. Table 3.2 shows the results brand positioning for males and females. By putting ideal points in brand positioning maps, a

joint space for males and females is shown in Figures 3.2 and 3.3. The space in these figures represents how consumers see each brand (Katahira (1989)).

Table 3.2 Brand positioning

Brand	Male		Female	
	$f(1)$	$f(2)$	$f(1)$	$f(2)$
<i>UCC</i>	-.907	.122	-.157	.893
<i>GEORGIA</i>	-.264	-.094	-.138	.042
<i>BOSS</i>	.681	.361	.693	-.451
<i>POKKA</i>	.311	-.353	-.223	-.391
<i>Jo</i>	.102	-.042	.043	-.836
<i>BLENDY</i>	-.431	-.066	.048	-.038

Table 3.3 Preference rate

Brand	Male	Female
<i>UCC</i>	1.06	1.24
<i>GEORGIA</i>	1.21	1.16
<i>BOSS</i>	1.09	0.67
<i>POKKA</i>	0.95	1.00
<i>Jo</i>	1.00	0.89
<i>BLENDY</i>	0.75	0.81

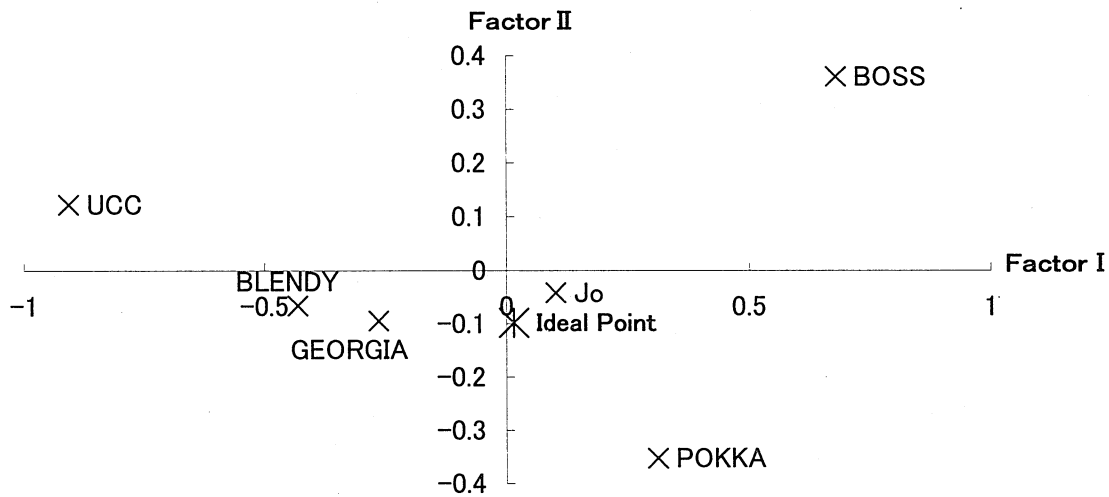

Figure 3.2 Joint space for males

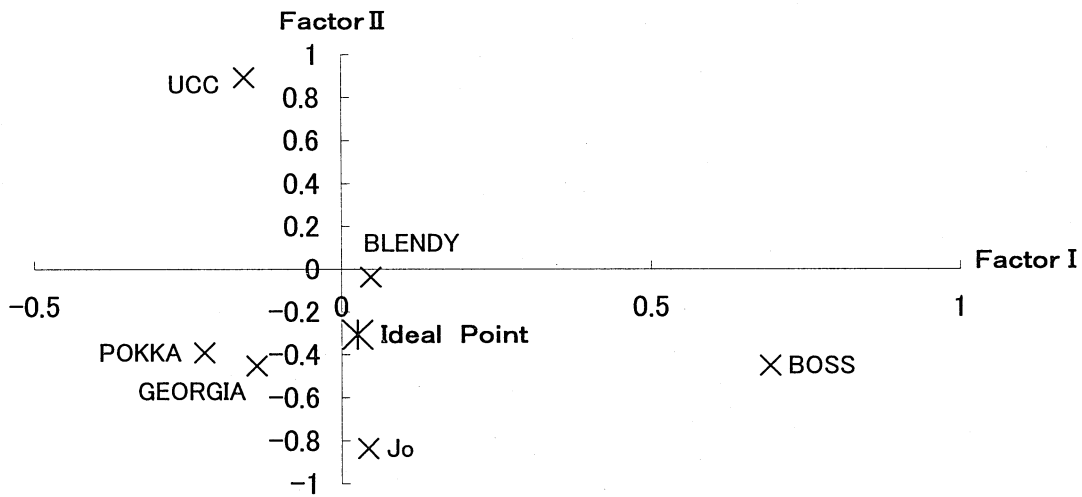

Figure 3.3 Joint space for females

(3) Preference rate

Using the constant-sum method of Comrey, preference rates of each brand are computed based on the chip allocation data for each brand and are given in Table 3.3. Both males and

females like *UCC* and *GEORGIA*, but only males prefer *BOSS*. The values of *BLENDY* are low for both groups. This could be caused because the degree of recognition as a new product remains in terms of a chip-allocation exercise.

(4) Ideal point

Using the power transformation centroid method, ideal points are calculated for $f(1)$ and $f(2)$. These results are given in Table 3.4, and ideal points are shown in Figures 3.2 and 3.3.

Table 3.4 Ideal point

	Factor I	Factor II
Male	.016	-.098
Female	.026	-.307

(5) Purchase probability

Using the multi-nominal logit model, purchase probabilities are estimated as follows: Purchase probability P_g are given by a linear function of the distance (d) between an ideal point and brand positioning. These results are shown in Tables 3.5 and 3.6.

Table 3.5 Purchase probability (P_g), distance between an ideal point and brand positioning (d), and estimated purchase probability (\hat{P}_g) for each brand (males)

$$\hat{P}_g = 0.1643 \times 1 + 0.0047 \times d$$

Brand	P_g	d	\hat{P}_g
<i>UCC</i>	.174	1.009	.168
<i>GEORGIA</i>	.202	.125	.165
<i>BOSS</i>	.179	.513	.167
<i>POKKA</i>	.155	.151	.166
<i>Jo</i>	.163	.877	.168
<i>BLENDY</i>	.127	.267	.166
Total	1.000	2.941	1.000

Table 3.6 Purchase probability (P_g), distance between an ideal point and brand positioning (d), and estimated purchase probability (\hat{P}_g) for each brand (females)

$$\hat{P}_g = 0.1519 \times 1 + 0.0352 \times d$$

Brand	P_g	d	\hat{P}_g
<i>UCC</i>	.216	1.474	.204
<i>GEORGIA</i>	.199	.148	.157
<i>BOSS</i>	.122	.465	.168
<i>POKKA</i>	.170	.069	.154
<i>Jo</i>	.152	.281	.162
<i>BLENDY</i>	.141	.073	.155
Total	1.000	2.511	1.000

By comparing the value of $\hat{\mathbf{P}}_g$ in Table 3.5, it can be seen that males tend to prefer *UCC*, *Jo* and *BOSS*, while females prefer *UCC* and *BOSS*. All of these brands are found relatively far from an ideal point. On the other hand, *GEORGIA* which is near an ideal point with a smaller \mathbf{d} is not favored, although it can attain high preference rates (\mathbf{P}_g) in both male and female groups. Further, the brand positioning of *GEORGIA* is near the original point which shows the smallest \mathbf{d} for males in a joint space. This indicates that *GEORGIA* is evaluated neither bitter nor sweet, and also neither good nor bad from everyone. That is, *GEORGIA* is coffee for *all people*.

(6) Market share

In order to estimate the market share, the parameters are calculated from (3.7), and the market shares of each brand are shown in Table 3.8. According to equation (3.5) for estimating the market share, probabilities of consumption for each brand coffee are estimated from ($\hat{\mathbf{P}}_{gN}$) based on the data given by the chip game. Then, these probabilities are used to estimate the expected consumption for each brand, which is divided by the total consumption of all coffee brands. Table 3.7 shows the values of each parameter to obtain market shares. We compute the market shares of each brand by inputting these values to (3.5), and give them in Table 3.8.

Table 3.7 Numerical summary of parameters to estimate market shares

	Male	Female
N_g Number in each group	50	50
U_g Average consumption Per one consumer	14.574	4.140
E_{gN} Probability of select in an evoked set		
<i>UCC</i>	0.88	0.84
<i>GEORGIA</i>	0.90	0.80
<i>BOSS</i>	0.66	0.48
<i>POKKA</i>	0.60	0.56
<i>Jo</i>	0.56	0.40
<i>BLENDY</i>	0.40	0.38
\hat{P}_{gN} Estimated purchase probability		
<i>UCC</i>	0.1684	0.2038
<i>GEORGIA</i>	0.1654	0.1572
<i>BOSS</i>	0.1667	0.1683
<i>POKKA</i>	0.1655	0.1544
<i>Jo</i>	0.1680	0.1618
<i>BLENDY</i>	0.1659	0.1545

Table 3.8 Market shares

Brand	Share
<i>UCC</i>	22.7 %
<i>GEORGIA</i>	21.2 %
<i>BOSS</i>	15.4 %
<i>POKKA</i>	14.2 %
<i>Jo</i>	13.0 %
<i>BLENDY</i>	10.5 %

3.5 Conclusions

The market share of a new product of *BLENDY* is estimated to be 10.5%. According to Nikkan Keizai Communication Co., the real shares of canned coffee in 1990 are: *GEORGIA* is 37%, *UCC* is 12% and *POKKA* is 10%. These shares differ considerably from the estimations presented in Table 3.8. The reason is that the model is limited to only 6 brands and questionnaires were given only by 100 participants at the age 20's. Better results could be achieved by taking up more brands and increasing the number of sample subjects.

Finally, a measure of brand selection has been based on the forced distribution of chips to each brand which compares in pairwise. Therefore, each brand has gotten *some distribution* (preference), which contributes to the overestimated market share for some brand in this chapter. But, in real brand situations, the brand selection is always *yes* or *no* and shares depend on such exclusive selection process. This is one of the reasons why the estimated shares have shown relatively small differences among brands, while the differences of real market shares on the present market are rather large.

Appendix

Questionnaire for the market prediction of canned coffee.

1. Brand Preference:

Put a ○ mark in the box next to each type of coffee when the statement is applicable after reading each of the following six statements one by one.

1. The coffee you drank recently.

A	UCC	:	COFFEE ORIGINAL	
B	GEORGIA	:	COFFEE ORIGINAL	
C	BOSS	:	BOSS BLEND	
D	POKKA	:	COFFEE	
E	ASAHI	:	Jo. WILD Jo.	
F	AGF	:	BLENDY RICHMILK	

2. The coffee you purchased recently.

(The same response box follows.)

3. The coffee you drink most often.

(The same response box follows.)

4. The coffee you have even drunk.

(The same response box follows.)

5. The coffee you want to try next time.

(The same response box follows.)

6. The coffee you don't want to purchase from now on.

(The same response box follows.)

2. Give a score to each brand attribute for the coffee brand stated below by putting a \bigcirc mark in each question . Follow the example below.

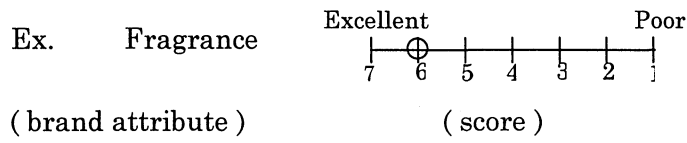

3. Divide 11 chips between a pair of coffee shown below according to the degree of your preference. Follow the example shown below.

Example.

coffee	chip		coffee	chip
UCC	(6)	vs.	GEORGIA	(5)
	6		+	5

= 11

- | | coffee | chip | | coffee | chip |
|-----|---------|------|-----|---------|------|
| 1) | UCC | () | vs. | GEORGIA | () |
| 2) | UCC | () | vs. | BOSS | () |
| 3) | UCC | () | vs. | POKKA | () |
| 4) | UCC | () | vs. | Jo. | () |
| 5) | UCC | () | vs. | BLENDY | () |
| 6) | GEORGIA | () | vs. | BOSS | () |
| 7) | GEORGIA | () | vs. | POKKA | () |
| 8) | GEORGIA | () | vs. | Jo. | () |
| 9) | GEORGIA | () | vs. | BLENDY | () |
| 10) | BOSS | () | vs. | POKKA | () |
| 11) | BOSS | () | vs. | Jo. | () |
| 12) | BOSS | () | vs. | BLENDY | () |
| 13) | POKKA | () | vs. | Jo. | () |
| 14) | POKKA | () | vs. | BLENDY | () |
| 15) | Jo. | () | vs. | BLENDY | () |

4. How many cans of coffee do you drink in a week?

Chapter 4

Stratified Analysis of Preferences on New Products

This chapter makes an analysis of the market share structure of perfume for young women, using the Herniter model. Preferences in 4 factors of the selected kinds of perfumes are analyzed; fragrance, price, design and name. The factors of preferences for each perfume are investigated on the market, and by applying collected data to the entropy model, their rates are numerically obtained. It is shown that more than 70% of consumers have already decided a factor of preferences for their favorite brand; 24.4% have selected for design, 22.9% for fragrance, 14.0% for price and 10.1% for name. Further, there are two strata of consumers; one selects according to only one factor of preferences and the other selects according to several factors.

4.1 Introduction

The entropy model has been considered in many fields of marketing science and applied to the studies of share prediction and evaluation of selection probability.

Ueda (1988) showed, using the influence of the price and selling trend was quite big. Gensch (1995), using the algorithm and maximum entropy principle in information theory, evaluated the selection probability and examined the technique from the real marketing data. Brockett (1995) researched the effectiveness of information theory approaching to various problems of market research regarding model, logarithm linear model, entropy model, logit model and brand switching model.

Ito (1987) calculated the weight ratio of several factors for women's preferences in fashion, using the entropy model. Herniter (1973) employed the entropy model and divided consumers into two strata; the non-fixed stratum of those who have not decided their purchases, and the fixed stratum of those who purchase only one brand. Herniter also calculated the market structure of non-fixed stratum. The theory of demanding the stratum ratio has been greatly developed by such studies.

This chapter investigates the perfume preferences among young women: Applying the entropy model, we calculate the preference ratio occupied by each factor, and seek the ratio of evaluation value of given factors (fragrance, price, design and brand) in each perfume. The consumers can be divided into two strata; one is consumers who choose according to only one factor, and the other is consumers who choose according to several factors. In particular, we give the main attention to the second stratum and to further distinctions within it. We try to calculate the preference ratio of each factor in the fixed stratum and the non-fixed stratum, using the Herniter Model.

4.2 Results of questionnaire

We select 20 kinds of perfume, which are popular and famous in Japan, with reference to two typical books of perfume (Fragrance Club (1996) and Ray Club (1996)). To investigate the properties of perfume preference, we show young women about some useful information which explain name, brand, fragrance, image and photograph of bottle, and make the following two questions:

- (1) Do you like or dislike the perfume?
- (2) By what reasons do you answer to question (1)? Select one factor from fragrance, price, design, brand and others.

The questionnaire is conducted on 162 young women. Table 4.1 gives the results of question (1). It would be natural that the number of *like* is greater than that of *dislike*, because most young women like perfume. There are fewer differences between market share than one expect. Further, Table 4.2 gives the results of question (2), where

- n_{si} is number of answers who like perfume s by factor i ,
- r_i is factor selection ratio in the non-fixed stratum inside,
- h_s is rate of liking perfume s .

It is shown that a half of women decide their favorite perfume by fragrance.

Table 4.1 Market shares of perfume in Japan

Items	Object Persons : 162					
	The like			The dislike		
	Number of persons : n_s	The rate : h_s		Number of persons : n_s	The rate : h_s	
1	121	6.73%		41	2.85%	
2	134	7.45%		28	1.94%	
3	111	6.17%		51	3.54%	
4	64	3.56%		98	6.80%	
5	119	6.61%		43	2.98%	
6	98	5.45%		64	4.44%	
7	90	5.00%		72	5.00%	
8	62	3.45%		100	6.94%	
9	100	5.56%		62	4.30%	
10	92	5.11%		70	4.86%	
11	60	3.34%		102	7.08%	
12	98	5.45%		64	4.44%	
13	76	4.22%		86	5.97%	
14	88	4.89%		74	5.14%	
15	84	4.67%		78	5.41%	
16	106	5.89%		56	3.89%	
17	72	4.00%		90	6.25%	
18	80	4.45%		82	5.69%	
19	75	4.17%		87	6.04%	
20	69	3.84%		93	6.45%	
Total	1799	100.00%		1441	100.00%	

Table 4.2 Market shares of factors

Factor Item s	The number of the answers according to the selection factor : $n_{s i}$						$\sum_{i=1}^4 n_{s i}$	The rate $h_{s i}$	
	Smell	Price	Design	Name	Others				
1	107	29	59	12	14		207	5.24%	
2	117	19	35	36	18		207	5.24%	
3	100	24	46	14	16		184	4.66%	
4	78	15	56	9	16		158	4.00%	
5	116	33	43	15	20		207	5.24%	
6	81	27	64	6	16		178	4.51%	
7	94	28	56	14	11		192	4.86%	
8	86	37	59	4	10		186	4.71%	
9	93	39	62	11	12		205	5.19%	
10	104	22	48	21	10		195	4.94%	
11	107	30	35	67	9		239	6.05%	
12	109	26	38	31	12		204	5.16%	
13	97	20	58	3	13		178	4.51%	
14	90	37	73	9	4		209	5.29%	
15	100	23	64	15	13		202	5.11%	
16	117	21	35	36	11		209	5.29%	
17	90	16	70	8	10		184	4.66%	
18	101	26	40	15	10		182	4.61%	
19	92	29	40	38	14		199	5.04%	
20	93	52	47	34	17		226	5.72%	
$\sum_s n_{s i}$	1972	553	1028	398	256		3951	100.00%	
$\sum_s \sum_i n_{s i}$	3951								
q_i	49.91%	14.00%	26.02%	10.07%					

4.3 Herniter model

There are generously two types of consumers in actual markets; consumers in one stratum select a product only by the name of brand and the others select it by other reasons. It would be difficult to estimate by what kinds of factors consumers select a product, however, it would be of great interest to investigate it.

To analyze the market structure, we need to form the market model as a starting point. For instance, we could investigate the inside structure of market on the basis of market shares of brands. One method is the entropy model that indicates the vagueness of market. Further, applying the Herniter model to market shares, we can investigate the selecting behavior of consumers in detail.

(1) Non- fixed stratum

Suppose that i ($i=1, 2, 3, 4$) represents factors of perfume; 1: fragrance, 2: price, 3: design, and 4: name. Letting r_i be the selecting rate of factor i in the non-fixed stratum, the selecting ratio of perfume s ($s = 1, 2, \dots, 20$) is

$$h_s \equiv \sum_{i=1}^4 \frac{n_{si}}{\sum_{i=1}^4 n_{ti}} \times r_i \quad (s = 1, 2, \dots, 20). \quad (4.1)$$

Further, the selecting rate of factor i is

$$q_i \equiv \frac{\sum_{s=1}^{20} n_{s i}}{\sum_{j=1}^4 \sum_{s=1}^{20} n_{s j}} \quad (i=1,2,3,4). \quad (4.2)$$

Thus, we consider the problem that minimizes

$$D_1 \equiv \sum_{i=1}^4 r_i \times \log \frac{r_i}{q_i}, \quad (4.3)$$

under the condition h_s given in (4.1).

We can solve the above problem by the iterative scaling method of Darroch and Ratchiff (1972), and give the following algorithm of computing the procedure:

Step 0: Compute the selecting rate of perfume s for factor i by

$$a_{s i} \equiv \frac{n_{s i}}{\sum_{s=1}^{20} n_{s i}} \quad (s=1,2,3, \dots, 20; i=1,2,3,4). \quad (4.4)$$

Step 1: Give the 0-th approximate probability of r_i by

$$r_1^{(0)} = q_1 = 0.4991, r_2^{(0)} = q_2 = 0.1400, r_3^{(0)} = q_3 = 0.2602, r_4^{(0)} = q_4 = 0.1007.$$

Step 2: Compute the 1-th approximate probability of r_i by

$$\begin{aligned}
 h_1^{(0)} &= \sum_{i=1}^4 a_{1i} \times r_i^{(0)} \\
 &= 0.0543 \times 0.4991 + 0.0524 \times 0.1400 + 0.0574 \times 0.2602 + 0.0302 \times 0.1007 \\
 &= 0.05241375, \\
 r_1^{(1)} &= r_1^{(0)} \times \prod_{j=1}^{20} \left(\frac{h_j}{h_j^{(0)}} \right)^{a_{j1}} \\
 &= 0.4991 \times (0.0673/0.05254)^{0.0543} \times (0.0745/0.0524)^{0.0593} \\
 &\quad \times (0.0617/0.0466)^{0.0507} \times (0.0356/0.0400)^{0.0396} \times (0.0661/0.0524)^{0.0588} \\
 &\quad \times (0.0545/0.0451)^{0.0411} \times (0.0500/0.0486)^{0.0477} \times (0.0345/0.0471)^{0.0436} \\
 &\quad \times (0.0556/0.0519)^{0.0472} \times (0.0511/0.0493)^{0.0527} \times (0.0334/0.0605)^{0.0543} \\
 &\quad \times (0.0545/0.0517)^{0.0563} \times (0.0422/0.0451)^{0.0492} \times (0.0489/0.0529)^{0.0456} \\
 &\quad \times (0.0467/0.0511)^{0.0507} \times (0.0589/0.0529)^{0.0593} \times (0.0422/0.0465)^{0.0456} \\
 &\quad \times (0.0445/0.0461)^{0.0512} \times (0.0417/0.0504)^{0.0467} \times (0.0384/0.0572)^{0.0472} \\
 &= 0.4931301089.
 \end{aligned}$$

Step 3: Continue until probability r_i converges. In this case,

$$r_1 = 0.9430, r_2 = 0.0001, r_3 = 0.0569, r_4 = 0.$$

(2) Herniter model

Let p_i ($i=1,2,3,4$) be the selecting rate of factor i in the fixed stratum and p_5 be that of other factors. Then, we consider the problem that minimizes

$$D_2 \equiv \sum_{i=1}^4 p_i \times \log \frac{p_i}{0.1906} + p_5 \times \log \frac{p_5}{0.2374}, \tag{4.5}$$

under the condition

$$p_i + p_5 \times r_i = q_i \quad (i = 1, 2, 3, 4). \tag{4.6}$$

By the same computing method, the solution is easily given by

$$p_1=0.2291, p_2=0.1400, p_3=0.2439, p_4=0.1007, p_5=0.2863.$$

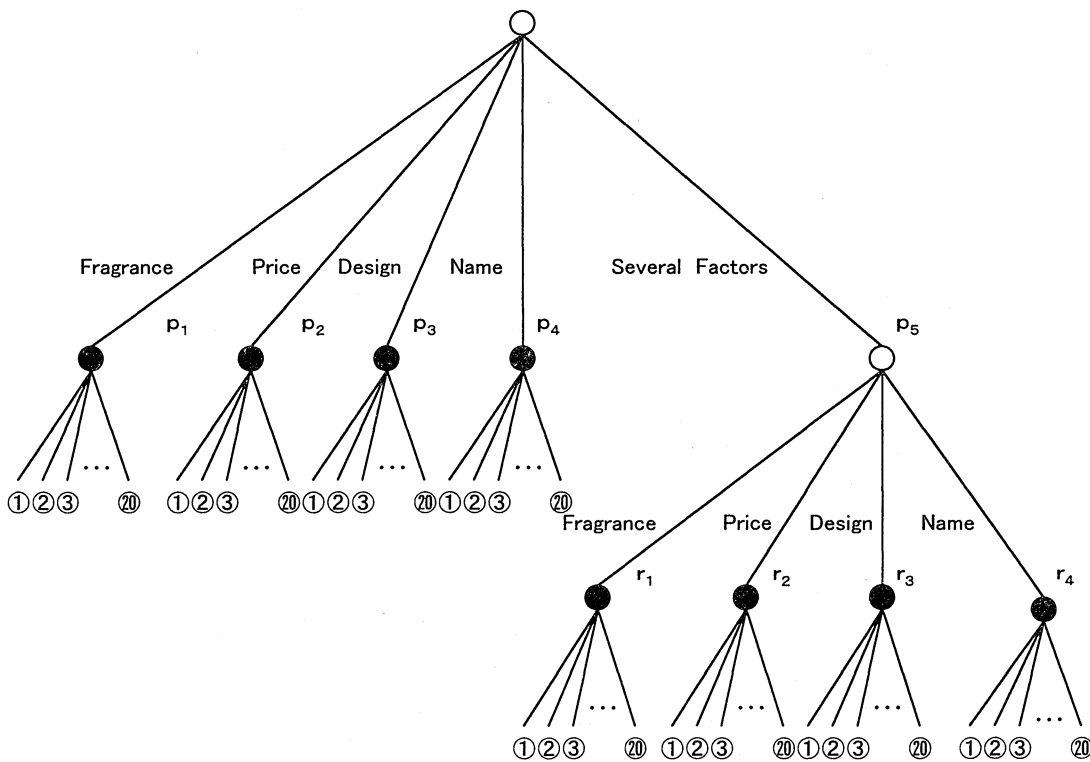

Figure 4.1 Tree of Hermiter model

(3) Transition probability

We draw the tree of the Herniter model in Fig. 4.1 which shows the market share of perfume, where p_i ($i=1,2,3,4$) represent the rate of factor i in the fixed stratum and p_5 represents the rate of selecting other factors in the non-fixed stratum. It is shown from Fig. 4.1 that consumers in the fixed stratum select the perfume by the same preference rate p_i , and consumers in the non-fixed stratum select it by the stratification rate p_5 at the first step, and after that, they select it by the preference rate r_i .

Suppose that $L(n)$ denotes a factor by which consumers select a perfume at the n -th step ($n = 1, 2, \dots$), and an event $\{L(n) = i\}$ represents that consumers select a perfume by factor i ($i=1,2,3,4$). Then, from (4.6), we easily have

$$\Pr\{L(n-1) = i\} = p_i + p_5 \times r_i \quad (i=1,2,3,4). \quad (4.7)$$

Further, joint probabilities are given by

$$\Pr\{L(n) = j, L(n-1) = i\} = \begin{cases} p_i + p_5 \times r_i^2 & \text{for } i = j, \\ p_5 \times r_i \times r_j & \text{for } i \neq j. \end{cases} \quad (4.8)$$

Because, when $i=j$, it is the sum of preference ratio p_i in the fixed stratum and (ratio p_5 in the non-fixed stratum) \times (the ratio r_i in the non-fixed stratum)². When $i \neq j$, it is (ratio p_5 in the non-fixed stratum) \times (preference ratio r_i in the non-fixed stratum) \times (ratio r_j in the non-fixed stratum).

Therefore, the transition probabilities are

$$p_{ij} \equiv \Pr\{L(n) = j \mid L(n-1) = i\}$$

$$= \begin{cases} \frac{p_i + p_5 \times r_i^2}{p_i + p_5 \times r_i} & \text{for } i = j, \\ \frac{p_5 \times r_i \times r_j}{p_i + p_5 \times r_i} & \text{for } i \neq j. \end{cases} \quad (4.9)$$

We give a numerical example of the transition probabilities in Table 4.3.

		Table 4.3 Transition probabilities p_{ij}			
		1	2	3	4
1	$\left(\begin{array}{cccc} 0.969163 & 0.000054 & 0.030783 & 0.000000 \\ 0.000193 & 0.999795 & 0.000012 & 0.000000 \\ 0.059047 & 0.000006 & 0.940947 & 0.000000 \\ 0.000000 & 0.000000 & 0.000000 & 1.000000 \end{array} \right)$	0.969163	0.000054	0.030783	0.000000
2		0.000193	0.999795	0.000012	0.000000
3		0.059047	0.000006	0.940947	0.000000
4		0.000000	0.000000	0.000000	1.000000

From Table 4.3, we derive the following result: Consumers purchase a perfume only for the reason of fragrance at 96.9%, and change into fragrance from design at 5.9%, and into design from fragrance at 3.1%.

4.4 Conclusions

We have understood that more than 70 % of the consumers decide their preference factor and select a perfume. The percentages of each factor are that design is 24.4 %, fragrance is 22.9 %, price is 14.0 %, and brand is 10.1 %. As for the preference factor among the non-fixed stratum, 94.3 % of consumers select according to fragrance, 5.7 % according to design, 0.01 % according to price, and 0 % according to brand. We pay the attention to the fact that

although it was thought that the non- fixed stratum would be 70-90 %, actually it was 30 %.

It has been understood that in the case of perfume, a high percentage of consumers already decide their preferences, and the order of factors in their preferences is design, fragrance, price, and brand. From those results, the classification analysis of preference according to the Herniter model is very effective for analyzing consumers' behavior.

Chapter 5

Perceptual Positioning of Products on Discriminant Analysis

When a new product will be developed and launched into the market, it is very essential to investigate and know the market structure and the competitor's positioning. A new product has to be placed on the market area which is not fully occupied by existing competitors. This chapter takes up the business of soft drinks which rush into an age of keen competition: The perceptual data which ask the benefit of 10 soft drinks are collected from questionnaires of 250 consumers. The correlation and discriminant analysis are made from these data and the diagram of positioning of soft drinks on the market is drawn. We discuss useful market strategies to plan what kinds of new soft drinks should be put on the market.

1.1 Introduction

It is necessary to develop new products, for companies to succeed on the full market of competing products. As an example, we take up soft drinks, where new types such as expensive but good have been on Japan market, after the price of canned juice sold from vending machines was raised from 100 yen to 110 yen, new types of drinks such as *expensive but good* have been on the market. This has stirred the quality-consciousness among consumers, and new drinks with high quality rather than low price have been much sought after.

Company A has recently introduced the idea of *high quality drink for the same price*, and made the sale of such drinks. This has changed the old thinking of canned juice which is *it is cheap, so anything will do*. For example, some companies are now carefully choosing the ingredient of coffee or tea, or are introducing the drinkable dessert like pudding or jelly. Another example of innovation is a drink whose taste changes depending on the number of shakes of the can.

It is of great interest that what kind of new drinks will be launched into the market, not only for companies, but also for consumers. This chapter examines the present situation of the market and researches the perceptual positioning of soft drinks among consumers.

5.2 Method

The analyses of correlation, distinction and mapping are made like Figure 5.1, using the results of questionnaire.

(1) Benefit evaluation data

The image investigation of soft drinks is made and the evaluation of benefits of the existing products among consumers is researched. The subjects of investigation are 250 consumers, and 10 kinds of soft drinks are selected, such as fruit juice, coffee, tea (including oolong tea), sports drink, carbonated drink, health drink, lactobacillus drink, refreshing drink and vegetable juice. Among many benefits which soft drinks give to consumers, 23 items such as taste, quality, container, drinking state, product image, and etc. are selected (see Table 5.1).

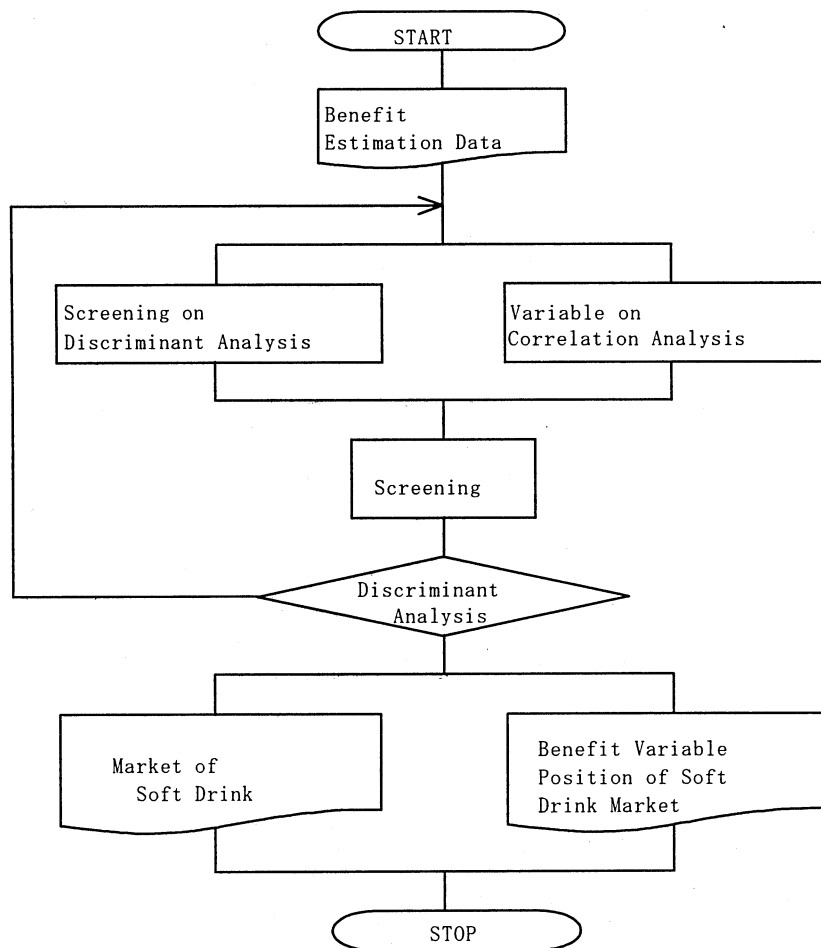

Figure 5.1

Flow chart of analysis

(2) Screening of discriminant analysis

The discriminant dimension based on the benefit evaluation data is selected. In order to choose the discriminant dimension, products with high correlation and low dispersion are chosen, and all correlations of such products are researched. If the correlation is low, its product is not chosen.

First, to seek correlation coefficients of discriminant dimension from benefit evaluation data provided by questionnaire investigation, we obtain the average, the dispersion and the common dispersion.

(3) Correlation analysis of variables

We seek attribute correlations of questionnaire items. Using the correlation analysis, we obtain 253 ways of attribute correlations in Table 5.2.

Table 5.2 Attribute correlations

		Mild		Total
		Yes	No	
Refreshing	Yes	1545 (<i>a</i>)	310 (<i>b</i>)	1855 (<i>a+b</i>)
	No	583 (<i>c</i>)	62 (<i>d</i>)	645 (<i>c+d</i>)
Total		2128 (<i>a+c</i>)	372 (<i>b+d</i>)	2500 (<i>a+b+c+d=N</i>)

Thus, phi coefficient is

$$\begin{aligned}\phi &= \frac{ad - bc}{\sqrt{(a+b)(c+d)(a+c)(b+d)}} \\ &= \frac{1545 \times 62 - 310 \times 583}{\sqrt{1855 \times 645 \times 2128 \times 372}} = -0.087,\end{aligned}$$

and chi-square value is

$$\begin{aligned}\chi^2 &= N \times \phi^2 \\ &= 2500 \times (-0.087)^2 = 18.9.\end{aligned}$$

From 2×2 table, χ^2 follows a chi square distribution with the degree of freedom 1. If the significant level is 0.1%, i.e., $\chi^2 \geq 10.8$, it is qualified as a category.

(4) Discriminant analysis

The discriminant analysis is done from the discriminant dimension and benefit variable. From the answers received through the discriminant analysis, each variable quantity becomes a composition variable one.

We select two composition variable quantities; one becomes the vertical line and the other is the cross axis. We output the mapping of the value of composition variable quantities and seek the validity of mapping. When the extreme polarity 1 and polarity 2 are appeared, we select the discriminant dimension and a variable, and redo the mapping.

(5) Product space of soft drinks

The positioning map is made, by turning the largest benefit variable and the next large one among the correlation ratios into the coordinate axes as the first and the second composition variable quantities, respectively. We indicate the center of gravity of composition variable quantities on the map as a coordinate point of each discriminant dimension. Further, we also indicate a coefficient correlation of benefit variables as a coordinate point. However, the indications of dimension and benefit variables near the starting point on the map are omitted, because they are little specified on the map.

(6) Position of benefit variable

We find out some spaces of market which are remote from the position of benefit variables among existing products. If there are spaces among products, new products which are fit for such spaces could be made.

Correlation coefficient of discriminant dimensions are shown in Table 5.3.

Table 5.3 Correlation coefficient

	1	2	3	4	5	6	7	8	9	10
	fruit juice	coffee	tea	oolong tea	sports drink	carbonated drink (soda)	health drink	lactic acid drink	refresher	vegetable juice
1 fruit juice	1	-0.0975	0.21051	0.12129	0.17838	0.14248	0.43415	0.76705	0.39605	0.56393
2 coffee	-0.0975	1	0.63387	-0.2786	-0.4334	-0.1755	-0.1379	-0.1417	-0.3363	0.11972
3 tea	0.21051	0.63387	1	0.08869	-0.3373	-0.2031	-0.4159	-0.0142	0.12280	-0.2171
4 oolong tea	0.12129	-0.2786	0.08869	1	0.39161	-0.1064	-0.0264	-0.0777	0.29542	-0.0700
5 sports drink	0.17838	-0.4334	-0.3373	0.39161	1	0.46556	0.32508	0.05282	0.68644	0.04475
6 carbonated drink(soda)	0.14248	-0.1755	-0.2031	-0.1064	0.46556	1	0.06141	-0.0023	0.61169	0.01468
7 health drink	0.43415	-0.1379	-0.4159	-0.0264	0.32508	0.06141	1	0.53345	-0.1081	0.75619
8 lactic acid drink	0.76705	-0.1417	-0.0142	-0.0777	0.05282	-0.0023	0.53345	1	0.17168	0.61119
9 refresher	0.39605	-0.3363	0.12280	0.29542	0.68644	0.61169	-0.1081	0.17168	1	-0.2611
10 vegetable juice	0.56393	0.11972	-0.2171	-0.0700	0.04475	0.01468	0.75619	0.61119	-0.2611	1
average	0.37163	0.01523	0.08679	0.13378	0.23738	0.18083	0.24218	0.29000	0.25784	0.25621
variance	0.11014	0.20798	0.19657	0.13164	0.19130	0.15240	0.19691	0.16267	0.18469	0.19375

5.3 Results

Items of coefficient correlation which is higher than 0.5 are selected. There are 18 variables. They are evaluated after calculating attribute correlations, and 15 variables are chosen. Figure 5.2 shows the positioning which describes a plot of composite variation, where the first correlation ratio is 0.608, and the second correlation ratio is 0.571.

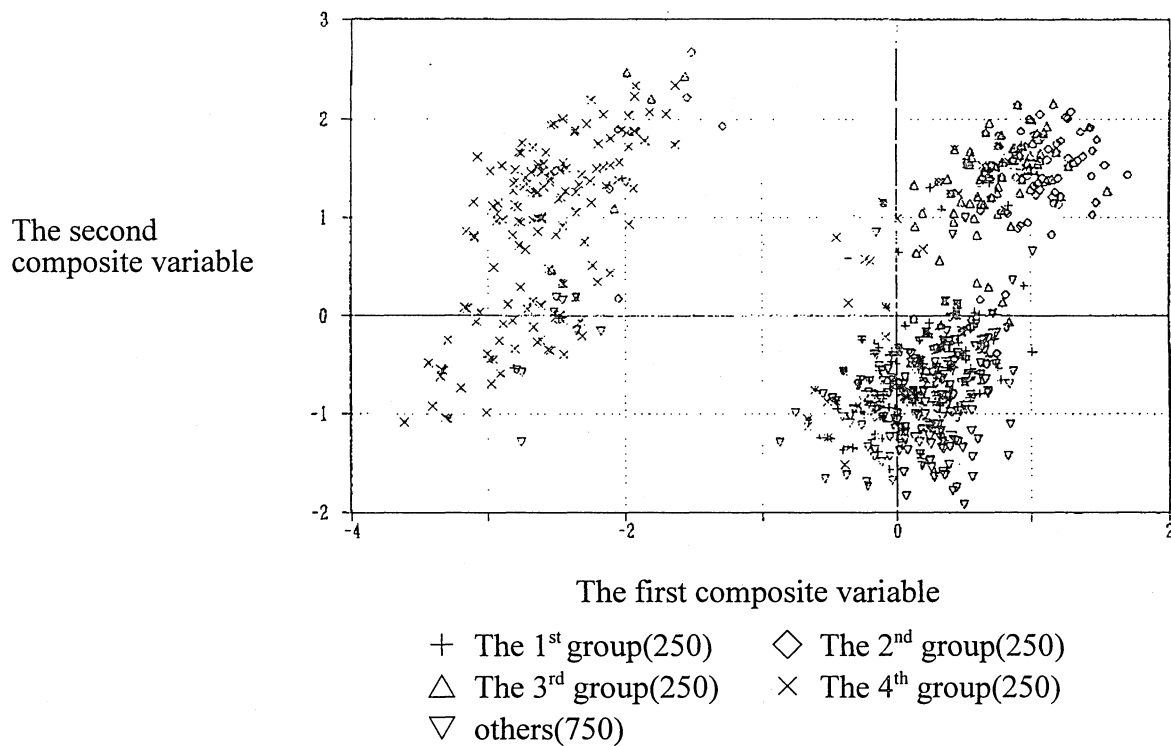

Figure 5.2 Positioning of composite variation

Further, Table 5.4 shows the result of the calculation of the center of gravity of composite variation. Figures 5.3 and 5.4 are the maps of results of benefit evaluation data of soft drinks given by the discriminant analysis.

Table 5.4 Centroid of composite variation

	The first composite vector	The second composite vector
Fruit Juice	0.11717	-0.3072
Coffee	0.96784	1.51931
Tea	0.51282	0.91613
Oolong tea	-2.6207	0.27891
Carbonated drink(soda)	0.29534	-1.1572
Sports drink	0.16639	-0.5517
Vegetable Juice	-0.2113	-0.6869

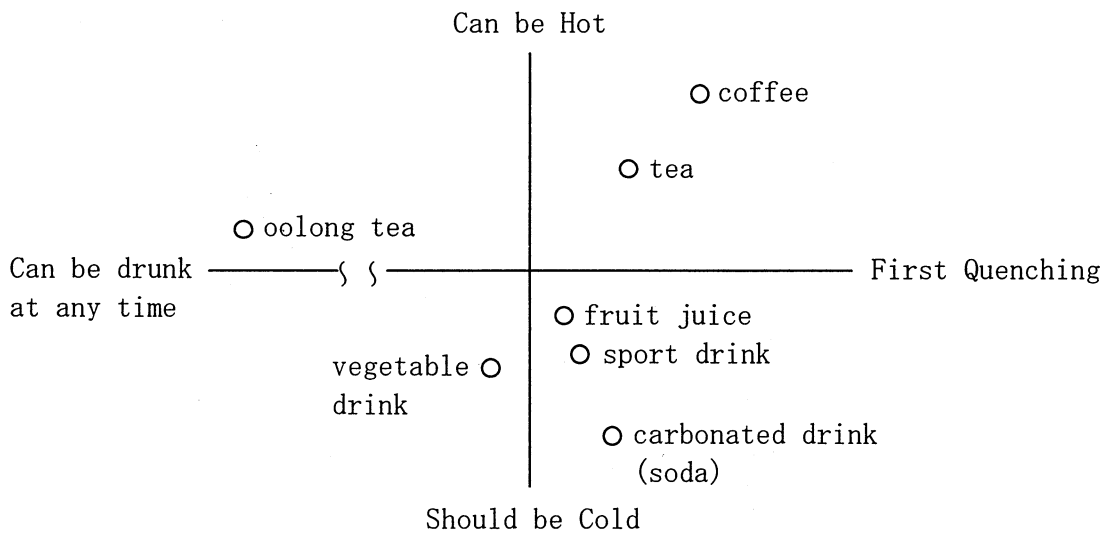

Figure 5.3

Positioning map of soft drink

We examine the marketability of new products whose coordinates are located within this graph.

- a) If a product similar to an existing one is introduced, it will not sell.

- b) A product has to target specific needs of consumers. If we cannot add specific needs to a new product even if it is unique, it will not have any marketing values.

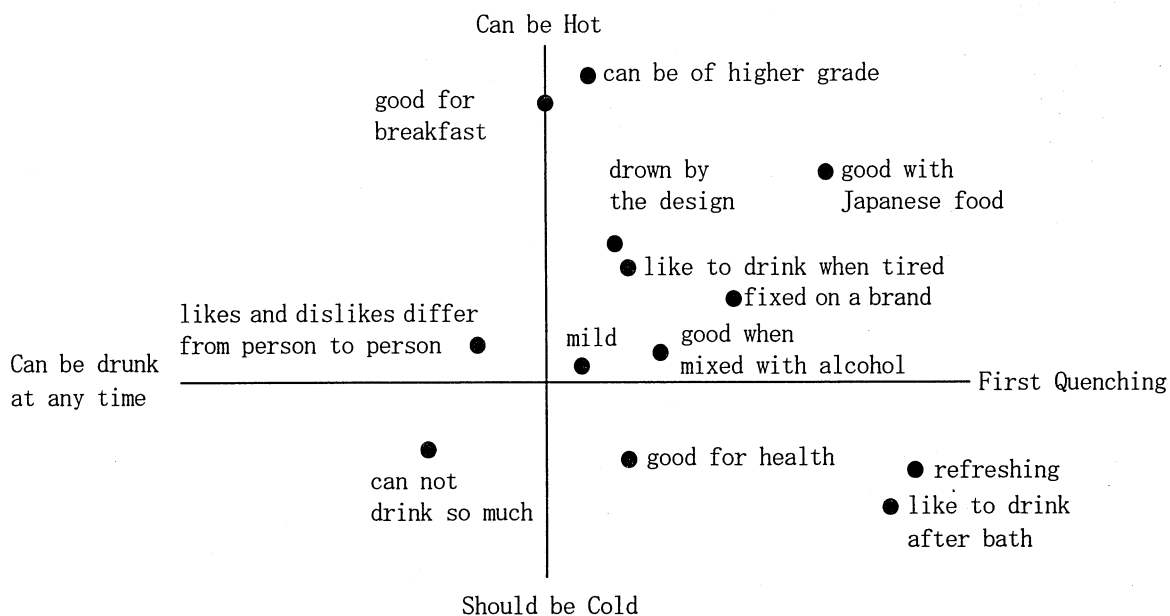

Figure 5.4

Positioning map of variable benefit

5.4 Conclusions

From Figures 5.3 and 5.4, we can see the sale chances of a new drink: There can be seen an open space in the second and third quadrants. If a new drink fitting into this space is launched into the market, it is able to have a marketing opportunity. It shows that a drink with the taste similar to tea or coffee, which can be drunk in a calm mood at any time, is the best. This would correspond to a kind of side drinks at breakfast.

It follows from the coefficient correlation of benefit variables that this drink could be of high quality and also be a hot one. That is, it could be like milk tea. It is quite clear from the table that tea is a drink which can be had at any time. Further, tea has traditionally been so

common and easily available drink at home that not many peoples were willing to buy it until recent years. For this reason, the vector of drinking tea was negative.

This also proves that the map of perceptual positioning would be useful not only for the understanding of the present market situation, but also to figure out what kinds of new drinks have a marketing chance.

Chapter 6

Perceptual Positioning of Products on Principal Component Analysis

When a new product will be developed and launched into the market, it is very essential to investigate and know the market structure and the competitor's positioning. A new product has to be placed on the market area which is not fully occupied by existing competitors. This chapter takes up the business of cellular phone which rushes rapidly into an age of keen competition: The perceptual data which ask the benefit of 4 kinds of cellular phone are collected from questionnaires of 250 consumers. The correlation and principal component analyses are made from these data, and the diagram of positioning of cellular phone on the market is drawn. We discuss useful market strategies to plan what kinds of new cellular phone should be on the market.

6.1 Introduction

Cellular phone has spread rapidly during the last several years. Especially, in Japan the use of cellular phone for the internet connection has been increasing. In August 2000 the number of subscription has passed 55 million, and it is still increasing. This chapter analyzes what kinds of cellular phone are accepted. The research is done on a group of university students (18-22 years old), and is concentrated on 4 companies of DoCoMo, IDO, J-PHONE and TU-KA. Students are asked to give their opinion on the score 1-5 for sound quality, connection area, ease of connection, charge plan and etc. We obtain the consumers' perception positioning of cellular phone and the market share prediction in search of an ideal vector.

6.2 Method

(1) Share model.

A share of new product X in the product space is predicted in the following:

- (1) A position of product X is decided in the product space, i.e., it is decided by the principal component analysis.
- (2) The distance with each consumer and product X is calculated.
- (3) Consumers suppose that the ratio, which a product near to a position of oneself is selected, is high.
- (4) A product is selected by this degree and its purchase probability is calculated.
- (5) The sum of purchase probabilities of each consumer is calculated and the market share of new product X is predicted.

The ratio, which a product is selected, is in proportion to a reciprocal number of distances. That is, the purchase probability p_x of new product X is given by

$$p_x = \frac{1}{d_x} \times \left(\frac{1}{\sum_{i=1}^m \frac{1}{d_{A_i}} + \frac{1}{d_x}} \right) \quad (6.1)$$

where p_x is the purchase probability of new product X ,

d_{A_i} is the distance from an ideal point of preexisting products

d_x is the distance from an ideal point of new product X .

Then, the market share X_m^* of new product X is

$$X_m^* = 100 \times \frac{\sum_{i=1}^n p_{x_i}}{n}, \quad (6.2)$$

where p_{x_i} is the purchase probability of a consumer.

(2) Questionnaire to consumers

The following questionnaire was done for 250 university students from 18 to 22 years old in February 2000 for 4 major companies of cellular phone: Evaluation items such as market share, connection area and function are 11 items. It is investigated whether you bought a cellular phone what company is made by. From this questionnaire result, we give the weight points of 0-4 to each evaluation item and calculate the evaluation points of 4 companies.

6.3 Results

Using the principal component load of 4 companies from the result of the principal component analysis, the scatter diagram is described in Figure 6.1. After setting the requirement of about 0.5 points for the first principal component, 4 items of connection area, ease of connection, model of machine and sound quality are given. Then, the first principal component is named *the ease of call*, which represents sound of incoming call. Similarly, the second principal component with 0.2 points is named *charge* and represents sound quality and charge plan. The third principal component with 0.25 points is named *corporate image* and represents the effects of commercial message and brand.

An ideal vector is obtained from these results, using the multiple regression analysis: At first, the component loading and principal component scores from the data main elements are obtained in Tables 6.1 and 6.2. Next, an ideal vector represented by the arrow in Figure 6.1 is obtained by the multiple regression analysis. An ideal vector of the first principal component and the second principal component is (0.99, -0.01), and that of the first principal component and the third principal component is (0.86, 0.14). Finally, an ideal vector of the second principal component and the third principal component is (0.87, 0.13).

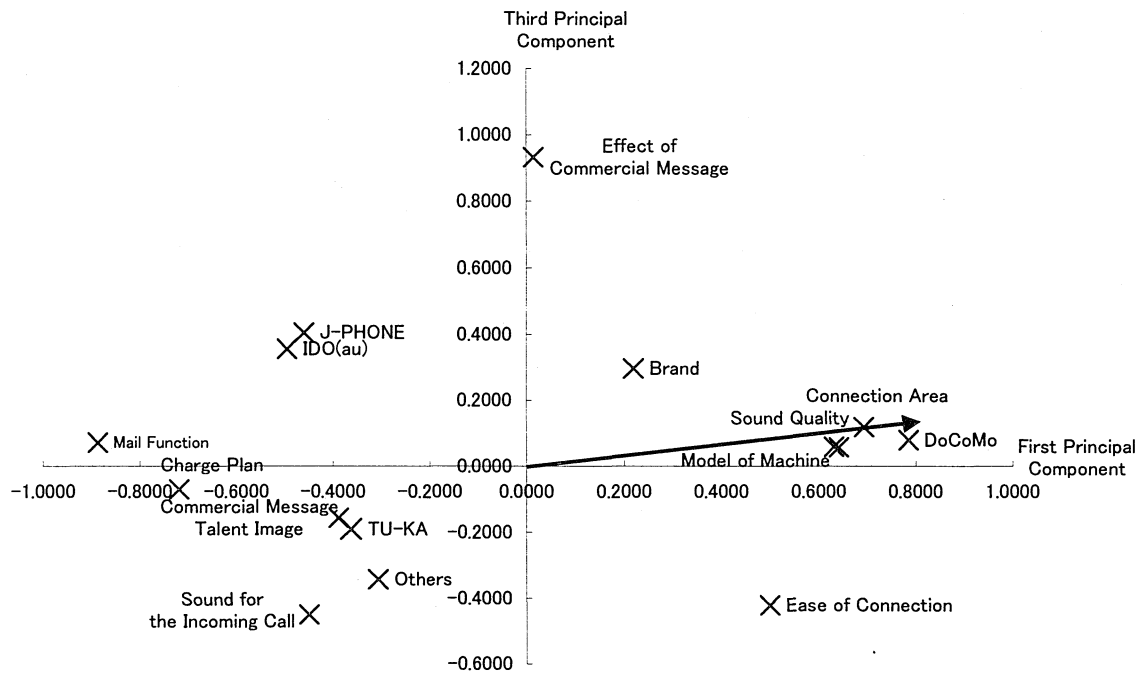

Figure 6.1. Figure of scatter

Table 6.1 Component loading of 4 companies

	First Principal Component	Second Principal Component	Third Principal Component
DoCoMo	0.7849	0.1356	0.0795
J-PHONE	-0.4598	0.1353	0.4050
IDO(au)	-0.4948	0.1498	0.3554
TU-KA	-0.3630	0.4469	-0.1900

Table 6.2 Principal component score of 4 companies

	First Principal Component	Second Principal Component	Third Principal Component
1. sound quality	0.6409	0.3017	0.0574
2. connection area	0.6931	0.1879	0.1190
3. ease of connection	0.4998	0.0788	-0.4214
4. charge plans	-0.7186	0.2118	-0.0697
5. mail function	-0.8874	0.0410	0.0716
6. sound for the incoming call	-0.4497	0.3297	0.2206
7. model of machine	0.6315	-0.3090	0.0595
8. brand	0.2189	-0.4848	0.2693
9. effect of commercial message	0.0146	-0.0528	0.9326
10. commercial message talent image	-0.3891	-0.4549	-0.1560
11. others	-0.3065	-0.3511	-0.3240

Table 6.3 Prediction of market shares and actual comparison of 4 companies

	Questionnaire result	Market share prediction	Market share in February(*)
DoCoMo	42.9%	35.8%	57.5%
J-PHONE	32.4%	22.3%	9.4%
IDO(au)	21.4%	24.3%	20.7%
TU-KA	9.5%	17.6%	12.4%

● Actual market share is data on all generations

The above approach is shown in the following: It is possible to grasp the positioning as the aim to introduce a new service. The positioning data of consumers is matched in the image. Further, prediction shares of each company are given in Table 6.3.

The results of this analysis are given from interviewing university students, and they do not represent the results of general population. As the result, DoCoMo has the highest prediction share among students, and the next in order are IDO, J-PHONE and TU-KA. By the result of analysis, it has been shown that the share of DoCoMo is the highest among 4 companies with 35.8%. The share of IDO is the second with 24.3%, and the share of J-PHONE is 22.3%, and TU-KA is 17.6%.

Cellular phone has rapidly spread during several years. These results would be greatly contributed not only to the popularization of cellular phone itself, but also of e-mail and internet.

6.4 Conclusions

This chapter has shown that DoCoMo has the largest share of the market. Consumers of their teens and 20s are the largest group in Japan. Therefore, each company has been intensified the efforts to target students and obtained them. DoCoMo has already started to offer the discount services in some areas. J-PHONE has always had a big number of student subscriptions. The new service for students will greatly affect the share rise in the future as well. It has been proven that there is a need for improvement regarding connection area and sound quality. In this aspect, DoCoMo has the widest area of connection and IDO follows.

Finally, the positioning has been carried out, using the principal component analysis of impression, and the questionnaire for each participant has been made on 11 items. The order of the present share size is DoCoMo, IDO, J-PHONE and TU-KA, where the shares of IDO and J-PHONE are almost even.

Chapter7

Optimal Product-Planning for New Products on Conjoint Analysis

While designing a new product, it is vital to grasp the consumers' evaluation of the present products. It is crucial for the product experimental design to clarify the degree of consumers' preferences of product attributes. The conjoint analysis, which is one of the marketing research techniques, is mainly used in such a situation. Since cup ramen in Japan is enormously popular among students, they are suitable for participants in the research. Using the orthogonal array, the preferences of consumers are analyzed, and the levels of preferences for each attribute (e.g., taste, size, price) are measured. Next, several product plans, including different levels of attributes, are proposed. It is shown as the result that male students prefer the LL size (143g) of servings and female ones prefer the straight taste of soy sauce. For both males and females, the preferred price is about 88 yen. The above data and conjoint analysis would be useful for the future optimal product planning.

7.1 Introduction

The time when any products have a good sale was over. Now only products which fulfill the needs of consumers are selling well. In order to respond to consumers' needs, companies have to study their preferences of goods and services, their selection criteria of those goods, and the attitudes towards the relationship between quality and price.

Cup ramen (chinese noodles) was developed in 1958, and was put on sale for the first time in 1971. After this, it has spread around the world, and now the yearly consumption reaches about 40 billion packages. Recently, it has become an indispensable part of menus of Japanese food.

Since it is very easy to cook cup ramen, it is kept in every household. For the purpose of this research, typical 16 types of cup ramen in Japan are prepared. The purpose of questionnaire is to find out answers to the following questions:

1. Which product is the most promising ?
2. Why do they choose this product ?
3. What is the most appropriate price ?
4. What is the best value for this price ?
5. If both the most popular and the most unpopular products are put on the market, what is the best price for both of them to sell?

Since cup ramen has great popularity among young people, this questionnaire is done for students. Questionnaires are handed out to 73 male and 73 female students with age 19-22 at the campus of Aichi Institute of Technology. Question items for sample students are shown in Appendix. Using the conjoint analysis, an optimal product planning for a new cup ramen is made based on this data.

The conjoint analysis measures the degree of importance which is given to particular aspects of product or service, i.e., it is an important technique which gives a concept of the development of new products. It would be rare that consumers are totally satisfied with products they have. For example, good products are generally expensive, or inexpensive ones are of poor quality. Then, consumers' buying behavior is observed and the priority of choice-value or quality is given through that. Further, while changing the levels of attributes, consumers are asked to set the order of their preferences. Such kind of optimization is called *conjoint analysis* method.

7.2 Selection of attributes

The conjoint analysis is based on the technique where opinions of consumers are not asked directly. Recently, even consumers themselves could not be sure what they exactly want. As a new method of analysis, consumers' preferences have recently surfaced, where their selection process is observed rather than asking direct questions. This is called *behavior analysis*. When consumers are asked about the reason for their purchase, they generally give only answers like *the quality is excellent*, or *they trust the company*. Companies should not accept such simple answers at the face value. Even when consumers are buying something at a special sale or at a grate discount, they would still give some routine answers. The conjoint analysis employs different strategies and all other present ways of investigating consumers' preferences. The conventional methods analyze general answers coming out of objective comparison, while the conjoint analysis is based on analyzing the subjective direct comparison of one item against another.

The conjoint analysis is represented in the flow chart below.

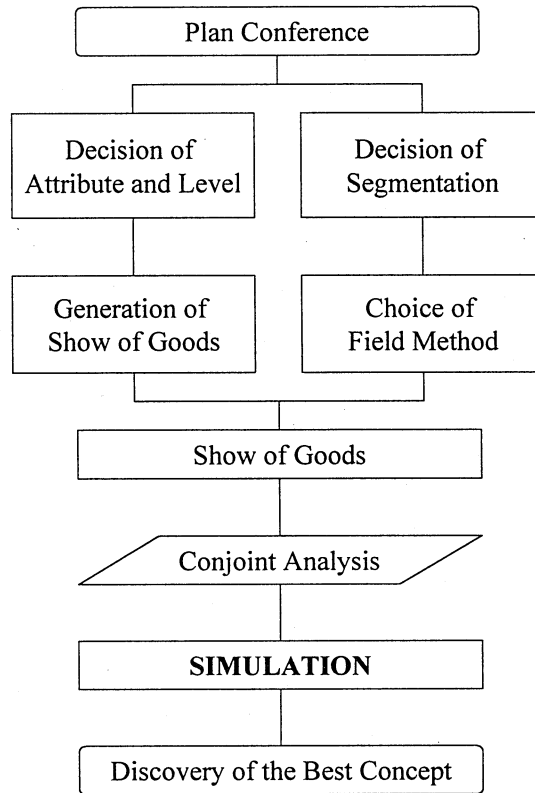

Figure 7.1 Flow chart of conjoint analysis

7.3 Application of conjoint analysis

A part worth x_{ij} is received as the result of attribute i and level j : If the level of attribute 1 is j , the level of attribute 2 is k , ..., and the level of attribute p is m , then the sum $a_{jk\dots m}$ of part worth of each attribute is defined as

$$a_{jk\dots m} = x_{1j} + x_{2k} + \dots + x_{pm} \quad (7.1)$$

The explanation is given in the following example: There are 3 attributes ($p = 3$), where attribute 1 has 2 levels ($c(1)=2$), attribute 2 has 3 levels ($c(2) = 3$), and attribute 3 has 4 levels ($c(3) = 4$). Each level in those three attributes carries out more partial effect as shown in

(a),(b) and (c) of Figure 7.2. It can be seen from this figure that the part worth (x_{12}) of level 2 of attribute 1, and the the part worth (x_{22}) of the level 2 of attribute 2, the part worth (x_{33}) of level 3 of attribute 3, and part worth (x_{34}) of level 4 of attribute 3 are all negative (Okada and Imaizumi (1994), Okamoto (1999), Urban and Hauser (1993)).

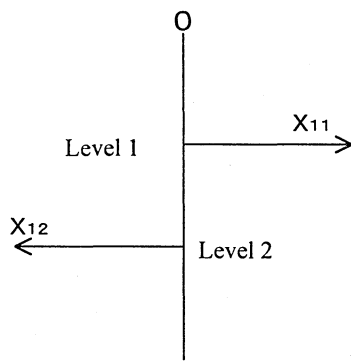

(a) Part Worth of Attribute 1

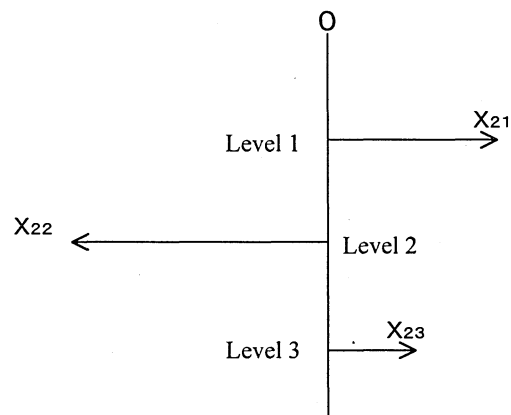

(b) Part Worth of Attribute 2

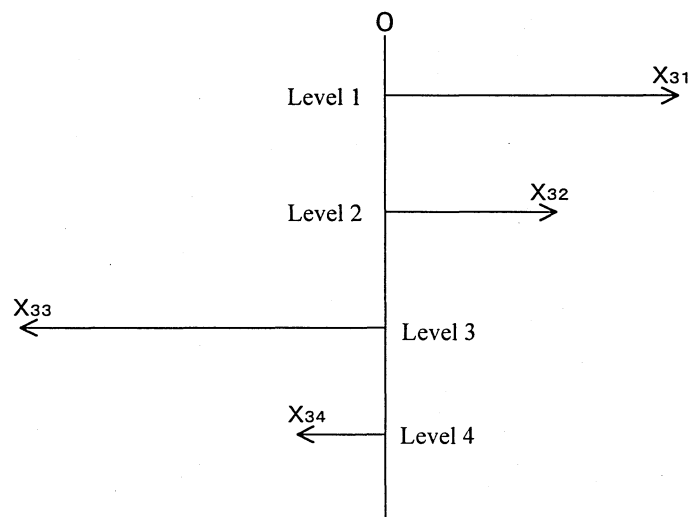

(c) Part Worth of Attribute 3

Figure 7.2

Part worth of attribute i ($i = 1, 2, 3$)

7.4 Calculation of contribution rate

The contribution rate is calculated as follows: First, the variance of the k -th attribute is

$$V_k = \frac{1}{m_k} \sum_{j=1}^{m_k} (u_{kj} - \bar{u}_k)^2 \quad (k = 1, 2, \dots, m), \quad (7.2)$$

where

m_k is the number of levels of the k -th attribute,

u_{kj} is partial effect value of the j -th level,

\bar{u}_k is the average of u_{kj} ($j=1, 2, \dots, m$).

Next, the contribution rate C_k of the k -th attribute is

$$C_k = \frac{V_k}{\sum_{l=1}^n V_l} \times 100 \quad (k = 1, 2, \dots, m). \quad (7.3)$$

Thus, the contribution rates of the part worth of each attribute are calculated by the variances of attributes.

7.5 Results of analysis

In the conjoint analysis, the variable that describes the specifications of a product is called *attribute*, and its concrete value is called *level*. Because both attribute and level give a great influence on the plans of a product, both of them should be clear and precise. Then, in order

to set up concrete standards, we make the research on the market. The attribute and level are given in Table 7.3.

In the present research, each of 3 attributes has 2 levels, and each of 4 attributes has 4 levels. If all of possible types are presented, then the total would become 2048 kinds, i.e., $2 \times 2 \times 2 \times 4 \times 4 \times 4 \times 4 = 2048$. It would be impossible physically and practically to do the research for all 2048 kinds.

The part worth of cup ramen is shown in Table 7.1, and its contribution rate is shown in Table 7.2.

Table 7.1 Part worth of cup ramen

Attribute	Level	Male n = 73	Female n = 73	Total
A	1	0.218	2.350	0.334
A	2	0.903	-0.686	0.484
A	3	0.573	-0.462	0.470
A	4	-1.694	-1.202	-1.288
B	1	-3.039	-0.783	-3.148
B	2	0.290	2.105	0.847
B	3	1.043	-0.061	1.307
B	4	1.706	-1.260	0.993
C	1	0.151	-0.293	0.029
C	2	-0.151	0.293	-0.029
D	1	0.226	-0.520	0.186
D	2	-0.226	0.520	-0.186
E	1	-0.322	-0.069	0.546
E	2	1.274	1.033	0.753
E	3	0.003	-0.655	0.034
E	4	-0.955	-0.309	-1.333
F	1	-0.303	0.423	-0.357
F	2	0.303	-0.423	0.357
G	1	0.823	1.630	1.304
G	2	0.129	-0.667	-0.005
G	3	0.026	0.378	0.036
G	4	-0.978	-1.342	-1.335

Table 7.2 Ratio of contribution

	Male	Female	Total
A	17.92%	31.70%	9.83%
B	58.77%	27.49%	58.81%
C	0.60%	2.13%	0.02%
D	1.35%	6.72%	0.92%
E	11.64%	6.61%	11.67%
F	2.43%	4.45%	3.38%
G	7.29%	20.90%	15.38%
Total	100.00%	100.00%	100.00%

Table 7.3 Attribute and level of cup ramen

Attribute	Level
A. Taste	1 = Soy sauce 2 = Miso 3 = Boned Pork 4 = Curry
B. Quantity	1 = S(38g) 2 = M(78g) 3 = L(103g) 4 = LL(143g)
C. Noodle	1 = Thin noodle 2 = Thick noodle
D. Type	1 = Uncooked type 2 = Dry type
E. Preparation Time	1 = 1 minute 2 = 2 minutes 3 = 3 minutes 4 = 4 minutes
F. Lid	1 = Yes 2 = No
G. Price	1 = 88 Yen 2 = 143 Yen 3 = 168 Yen 4 = 200 Yen

Table 7.4 Orthogonal design of cup ramen

Attribute							
	A. Taste	B. Quantity	C. Noodle	D. Type	E. Preparation Time	F. Lid	G. Price
Model 1	1	1	1	1	1	1	2
Model 2	1	2	2	2	2	1	1
Model 3	1	3	1	2	3	2	3
Model 4	1	4	2	1	4	2	4
Model 5	2	1	2	1	2	2	1
Model 6	2	2	1	1	4	1	3
Model 7	2	3	2	2	3	1	4
Model 8	2	4	1	2	1	2	2
Model 9	3	1	1	2	4	2	3
Model 10	3	2	2	1	3	2	4
Model 11	3	3	1	1	2	1	2
Model 12	3	4	2	2	1	1	1
Model 13	4	1	2	2	4	1	4
Model 14	4	2	1	2	2	2	2
Model 15	4	3	2	1	1	2	1
Model 16	4	4	1	1	3	1	3

Using the orthogonal array of an experimental design, the number of types is reduced to 16. The orthogonal array of cup ramen is shown in Table 7.4 (Kamijyou (1984) and Katahira (1989)).

Table 7.5 Optimal plan of cup ramen

	Male	Female	Total
Taste	Miso	Soy sauce	Miso
Quantity	143g (LL)	78g (M)	103g (L)
Noodle	Thin	Thick	Thin; Thick
Type	Uncooked type	Dry type	Uncooked type
Cooking Time	2 minutes	2 minutes	2 minutes
Lid	Yes	No	Yes
Price	88 Yen	88 Yen	88 Yen

7.6 Conclusions

As a result of the simulation, the following optimal plan is made: A high proportion of males put the main emphasis on the volume. Females put equal emphasis on taste, quantity and price. Also, when the opinion of both genders is put together, the volume is still greatly emphasized. As for the price, both males and females prefer it to be low. Since the present research has been done among students, the main emphasis has been put on the volume, price, preparation time and taste. The contribution ratio reaches 95.6% just between those four attributes. From those results, the optimal plan is shown in Table 7.5.

Appendix

Model	1	2	3		16
Taste	Miso	Soy sauce	Miso		Curry
Quantity	143g (LL)	78g (M)	103g (L)		38g(S)
Noodle	Thin noodle	Thick noodle	Thin noodle		Thick noodle
Type	Uncooked type	Dry type	Uncooked type	...	Dry type
Cooking Time	2 minutes	2 minutes	2 minutes		1 minute
Lid	Yes	No	Yes		No
Price	88 Yen	88 Yen	88 Yen		143 Yen

Chapter 8

Conclusions

This thesis has suggested the following five scientific techniques in order to grasp consumers' needs and behavior:

1. Markov Model
2. Preference Model
3. Entropy Model and Herniter Model
4. Perception Positioning
5. Conjoint Analysis

In the Markov model, using the 1981 market share of 4 beer companies; Kirin (62.9%), Asahi (10.4%), Sapporo (20.0%) and Suntory (6.7%), a transition probability matrix of each kind of beer is calculated, and the prognosis of the market share of those kinds of beer has been estimated for the next years. By such calculations, the market shares of the base (0) year, the 10th (1991) and the 20th (2001) year have been compared. The prognosis of the market share has shown that Kirin's share would decrease, and in those particular years, it is 62.9%, 50.8% and 46.3%, respectively. Further, Asahi's share would increase from 10.4% to 23.2% and 30.0%, respectively, and Sapporo's share would decrease from 20.0% to 18.0% and 16.2%, respectively. Further, Suntory's share has been predicted to increase from 6.7% in 1981 to 8.1% in 1991, only to fall to 7.5% in 2001. By comparing the estimation until 1991 with the

real data of the same period, we can see that the prognosis are only slightly off target.

In this thesis, the prediction of market shares has been relatively accurate, but actually considering a transition probability, it is very difficult to give the prediction for a long period of time. At the present, the following models have been developed:

In the preference model, a market share of a new product *BLENDY* is estimated to be 10.5%. According to Nikkan Keizai Communication Co., the real shares of canned coffee in 1990 are: *GEORGIA* is 37%, *UCC* is 12% and *POKKA* is 10%. These shares differ considerably from the estimations presented in Table 3.8 in Chapter 3. The reason is that the model is limited to only 6 brands and questionnaires were given only to 100 participants in their 20's. Better results could have been achieved by taking up more brands and increasing the number of sample subjects and widening the age brackets.

Finally, a measure of brand selection is based on the forced distribution of chips to each brand compared pairwise. Therefore, each brand can get *some distribution* (preference), which contributes to the overestimated market share for some brand. But, in real brand selection situations, the selection of brand is always *yes* or *no* and shares depend on this exclusive selection process. This is one of the reasons why estimated shares have shown relatively small differences among brands, while real market share differences are rather large.

In the entropy and Herniter models, we have understood that more than 70% of consumers decide their preference factor about the selection of perfume, and then, they select it. The percentages of each factor are that design is 24.4 %, fragrance is 22.9 %, price is 14.0 %, and brand is 10.1 %. As for the preference factor among the non-fixed stratum, 94.3 % of consumers select according to fragrance, 5.7 % according to design, 0.01 % according to price,

and 0 % according to brand. We should pay the attention to the fact that although the non-fixed stratum would be thought to be 70-90 %, it is actually 30 %. This indicates that in the case of perfume, high percentages of consumers have already decided their preferences. The order of factors in their preferences is design, fragrance, price, and brand. From those results, the classification analysis of preference according to the Herniter model is very effective for analyzing of consumers' behavior.

In the perception positioning, from Figures 5.3 and 5.4 we can see the sale chances of a new drink in an open space of the second and third quadrants. If a new drink fitting into this space is launched into the market, it is able to have a marketing opportunity. This indicates that a drink with the taste similar to tea or coffee, which can be drunk in a calm mood at any time, is the best. To be more specific, one kind of side drinks at breakfast would be good.

It follows from the correlation coefficient of benefit variables that this drink is of high quality and is a hot one. Therefore, it could be a drink like milk tea. It is quite clear from the table that tea is a drink which can be had at any time. Further, tea has traditionally been so common and easily available drink at home that not many peoples were willing to buy it until recent years. For this reason, the vector of drinking tea was negative. This has proved that the map of perceptual positioning can be useful not only for the understanding of the present market situation, but also to figure out what kinds of new drinks have a marketing chance.

Further, using the perception positioning, it has been shown in a different study that DoCoMo has the largest share in the market. Consumers in their teens and 20's are the largest group. Therefore, each company of cellular phone has intensified the efforts in targeting students. DoCoMo has already started to offer the discount services in some areas. J-PHONE has always had a big number of student subscriptions. New services for students will greatly affect the share rise in the future as well. It has been shown that there is a need for

improvement regarding connection area and sound quality. In this aspect, DoCoMo has the widest area of connection and IDO follows. Finally, the positioning has been carried out, using the principal component analysis of the impression. The order of the present share size is DoCoMo, IDO, J-PHONE and TU-KA, while the shares of IDO and J-PHONE are almost even.

In the conjoint analysis, the following optimal plan for cup ramen has been made: A high proportion of males put the main emphasis on the volume, and females put equal emphasis on taste, quantity and price. Also, when the opinion of both genders is put together, the volume is still greatly emphasized. As for the price, both males and females prefer it to be low. Since the present research has been done among students, the main emphasis has been put on the volume, price, preparation time and taste. The contribution ratio has reached 95.6% just between those 4 attributes. From those results, the optimal plan is shown in Table 7.5.

Finally, there are several methods of analysis of consumers' needs and behavior in the mathematical marketing model:

1. Markov Model: Know brand transition in a Markov chain, and calculate market shares in an equilibrium state. As a result, we can suggest the next strategy which business should take.
2. Preference Model: The predict marketability of new products is given, i.e., the purchase probability of each brand is given, according to consumers' preference data for each brand. This would be able to make the product development for consumers' need.
3. Entropy Model: A transition probability can be estimated by using a market share vector, and the market structure can be evaluated.
4. Perception Positioning: Perception mapping is useful not only to understand the present market share, but also to find marketing opportunities for new products.

5. Conjoint Analysis: The conjoint analysis is a very useful method of obtaining an optimal planning, because it can evaluate quantitatively consumers' preferences regarding several aspects of product.

The above five techniques are very efficient and beneficial in the actual performance of this analysis, and thus, directly make a target influence for the success of products on the market.

Bibliography

- [1] Akaer, D.A. and Day, G.S. (1990), "Marketing Research (4th)", John Wiley & Sons.
- [2] Arima, S. and Ishimura, S. (1987), "Story of Multivariate Analysis", Tokyo Tosho CO.,LTD., pp.21-36.
- [3] Asano, H. (1990), " Marketing Simulation", Doyukan, pp.21-33.,pp.37.,pp.128-131.
- [4] Brockett,P.L.,Charnes,A.,Cooper.W.W.,Learner.D.and Phillips,F.Y.,(1995), "Information theory as unifying statistical approach for use in marketing research", European Journal of Operational Research, Vol. 84, pp.310-329.
- [5] Colombo, R. A. and Morrison, D. G. (1989), "A brand switching model with implications for marketing strategies", Marketing Science, Vol. 8, pp.89-99.
- [6] Comrey,A.L. (1950), "A proposed method for absolute ratio scaling", Psychometrika, Vol. 15, pp.317-325.
- [7] Darroch,J.N. and Ratchiff,D. (1972), "Generalized iterative scaling for long-linear models", The Annals of Mathematical Statistics., Vol. 43, pp.1470-1480.
- [8] Ehrenberg,A.S.C. (1965), "An appraisal of Markov brand-switching models", Journal of Marketing Research, Vol. 2, pp.347-362.
- [9] Fragrance Club,(1996), "Perfumes Selection 280", Nagaoka Press.
- [10] Gensch,D.H. and Soofy,E.S. (1995), "Information-theoretic estimation of individual consideration set", International Journal of Research in Marketing, Vol. 12, pp.25-38.
- [11] Green, P.E. and Srinivasan, V. (1990), "Conjoint analysis in marketing, new developments with implications for research and practice", Journal of Marketing, Vol. 54, pp.3-19

- [12] Herniter, J.D. (1973), "An entropy models of brand purchase behavior", *Journal of Marketing Research*, Vol. 10, pp.361-375.
- [13] Hideki Katahira(1989), "Marketing Science", Tokyo University Publication Society, pp.123-146.
- [14] Hiromatsu, T., Tanaka, A., Tokiwa, Y. and Kogure, M.(1991), "Introduction to Statistics with Loutus 1-2-3", Asakura Publishing CO.,LTD..
- [15] Howard, J.A. and Sheth, J.N. (1969), "The Theory of Buyer Behavior", John Wiley & Sons.
- [16] Ishihara, T., Hasegawa, K. and Kawaguchi, T.(1990), "Multivariate Analysis for Loutus 1-2-3", Kyoritsu Shuppan Co., Ltd., pp.84-106.
- [17] Ishihara, T., Hasegawa, K. and Kawaguchi, T.(1990), "Multivariate Analysis for Loutus 1-2-3", Kyoritsu Shuppan Co., Ltd., pp.348-362.
- [18] Ishiwata, T.(1991), "Marketing Model [2]", Kyoritu Shuppan Co.,Ltd., pp.93-109.
- [19] Ito, I. (1987), "An evaluation of preferences about fashions using entropy model", *The Japanese Journal of Ergonomics*, Vol. 23, pp.1-6.
- [20] Kamijyou, K., (1984). "Introduction to Design of Experiments for Personal Computer", Kougaku Press, pp.25-50.
- [21] Katahira, H. (1989), "Marketing Science", University of Tokyo Press, pp.123-189.
- [22] Katahira, H. (1991), "A New Approach to Consumer Choice Analysis", *Theory and Application of LOGMAP*, University of Tokyo Press.
- [23] Kuehn, A. A.(1961), "A model for budgeting advertising", in Frank, M.B. et al. (eds.) *Mathematical Models and Methods in Marketing*, Richard D. Irwin, pp.302-356.
- [24] Kuehn, A. A. and Day, R.L., (1964), "Prababilistic models of consumer buying behavior", *Journal of Marketing*, Vol. 28, pp.27-31.
- [25] Kunisawa, K.(1975), "Entropy Model", JUSE Press, pp.74-80, pp.95-97.
- [26] Lipstein, B.: (1965), "A mathematical model of consumer behavior", *Journal of Marketing Research*, Vol. 2, pp.259-265.

- [27] Louviere, J.J. and Woodworth, G.(1986), "Design and analysis of simulated consumer choice or allocation experiments, an approach based on aggregate data", *Journal of Marketing Research*, Vol. 20, pp.350-367.
- [28] Luce, R.A and Tukey, J.W. (1964), "Simultaneous conjoint measurement, a new type of fundamental measurement", *Journal of Mathematical Psychology*, Vol. 1, pp.1-27.
- [29] Morimura, H. and Takahashi, T. (1979), "Markov Analysis" JUSE Press, Ltd.
- [30] Muto, S. and Asano, H.(1986), " A Research Guide for the New Product Development" , Yuhikaku Publishing Co.,Ltd., pp.33-61,186-195.
- [31] Okada,A. and Imaizumi,T., (1994), "Multidimensional Scaling Methods," Kyouritu Press.
- [32] Okada, T., Terazima, K. and Koside, H.,(1987), "Marketing Game Using PC-9801 Machine", *The Nikkan Kougyou Sinbun*.,Ltd., pp.74-80.
- [33] Okamoto, H. (1999), "Conjoint Analysis, Marketing Research by SPSS", Nakanishiya Shuppan.
- [34] Ray Club,(1996), "Perfumes top- selection100", Syuhunotomo Press.
- [35] Ross,S.M. (1970), "Applied Probability Models with Optimization Application", Holden-Day, San Francisco.
- [36] Saito, T. (1990), "The liquor refreshing drinks world", *Kyoritu Shuppan Co*.,Ltd., pp.125-136.
- [37] Silk, A. and Urban, G.L.(1978), "Pre-test- market evaluation of new packaged goods: A model and measurement methodology", *Journal of Marketing Research*, Vol. 15, pp.171-191.
- [38] Styan, G. P. H. and Smith, H. Jr. (1964), "Markov chains applied to marketing," *Journal of Marketing Research*, Vol. 1, pp.50-55.
- [39] Sukeyori S.(1975), "Behavioral Science at Correlation Analysis Method", University of Tokyo Press.

- [40] Tanaka, Y. and Wakimoto, M.(1991), "Multivariate Analysis Method", Gendai-Suugaku CO.,LTD., pp.102-136.
- [41] Theil, H. and Rey, G. (1966), "A quadratic programming approach to the estimation of transition probabilities," Management Science, Vol. 12, pp.714-721.
- [42] Ueda,Y. (1988), "The total picture of measurement analysis enforcement of car market", The 1988 Autumn National Conference of Operations Research Society of Japan, Abstracts, 2D3, pp.188-189.
- [43] Urban,G.L. and Hauser, J.R., (1980), "Design and Marketing of New Products", Prentice-Hall, Inc., pp.253-279, 449-492.
- [44] Urban G.L., Hauser, J.R. and Dholakia, N., (1987), "Essentials of New Product Management", President Inc., pp.168-221.
- [45] Yoshida, M., Murata, S. and Izeke, T. (1979), "Analysis Model of Consumer Behavior," Maruzen, pp.29-66.

Publication List of the Author Concerning This Dissertation:

Chapter 2

1. Kazuyuki Teramoto, and Takaharu Ogawa:
 “A Transition Model of Market Share on Markov Process”
 THE OPERATIONS RESEARCH SOCIETY OF JAPAN, A-1-5-118, 2000.

Chapter 3

1. Kazuyuki Teramoto, Kazumi Yasui and Toshio Nakagawa:
 “Estimation of the Marketing Share of a New Can-Coffee in Japan”
 SYSTEMS SCIENCE AND SYSTEMS ENGINEERING, pp. 514-517, 1998.
2. Kazuyuki Teramoto:
 “A Method of Estimation Brand Preference of New Canned Coffee in Japan”
 JAPANESE JOURNAL OF ADMINISTRATIVE SCIENCE, Vol. 15, No. 2,
 pp.171-179, 2001.

3. Kazuyuki Teramoto:

“Estimation of Purchase Probability on Preference Model”

JOURNAL OF JAPAN ASSOCIATION FOR MANAGEMENT SYSTEMS,
Vol. 17, No. 1, pp. 55-60, 2000.

Chapter 4

1. Kazuyuki Teramoto:

“An Entropy Model to Evaluate Perfume Preference”

JOURNAL OF JAPAN ASSOCIATION FOR MANAGEMENT SYSTEMS,
Vol. 15, No. 2, pp.13-18, 1999.

2. Kazuyuki Teramoto, Takashi Usami and Toshio Nakagawa:

“Stratified Analysis of Preferences on Market Share of Perfume”

*PROCEEDINGS OF THE FIRST WESTERN PACIFIC AND THIRD
AUSTRALIA-JAPAN WORKSHOP ON STOCHASTIC MODELS IN
ENGINEERING, TECHNOLOGY AND MANAGEMENT*, pp. 520-527, 1999.

Chapter 5

1. Kazuyuki Teramoto, Takashi Usami, Hiromi Yamada, and Toshio Nakagawa:

“Perceptual Positioning of Soft Drink on the Japan Market”

*INTERNATIONAL CONFERENCE ON APPLIED STOCHASTIC SYSTEM
MODELING*, pp. 224-231, 2000.

Chapter 6

1. Kazuyuki Teramoto, Takashi Usami, Hiromi Yamada, Kenichiro Naruse and Toshio Nakagawa:

“Perceptual Positioning of Cellular Phones on the Japan Market”

PROCEEDING OF THE THIRD ASIA-PACIFIC CONFERENCE ON INDUSTRIAL ENGINEERING AND MANAGEMENT SYSTEM, pp. 565-568, 2000.

Chapter 7

1. Kazuyuki Teramoto, Takashi Usami, Hiromi Yamada, Kenichiro Naruse and Toshio Nakagawa:

“Optimal Product-Planning for a New Cup Ramen (Chinese Noodle) on Conjoint Analysis”

16TH INTERNATIONAL CONFERENCE ON PRODUCTION RESEARCH, F5-4, 2001.

2. Kazuyuki Teramoto and Takashi Usami:

“Optimal Product-Planning for a New Cup Ramen (Chinese Noodle) on Conjoint Analysis”

JOURNAL OF JAPAN ASSOCIATION FOR MANAGEMENT SYSTEMS, Vol. 18, No. 2, 2002.